

# RADIO AGE

RESEARCH · MANUFACTURING · COMMUNICATIONS · BROADCASTING

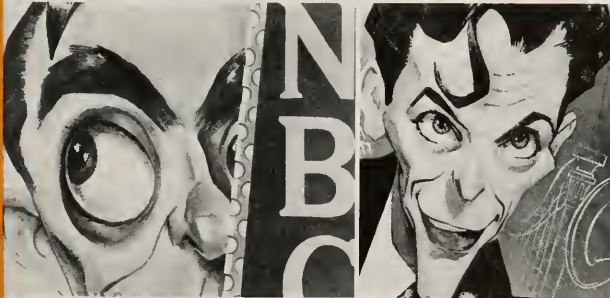

P A R A D E O F S T A R S

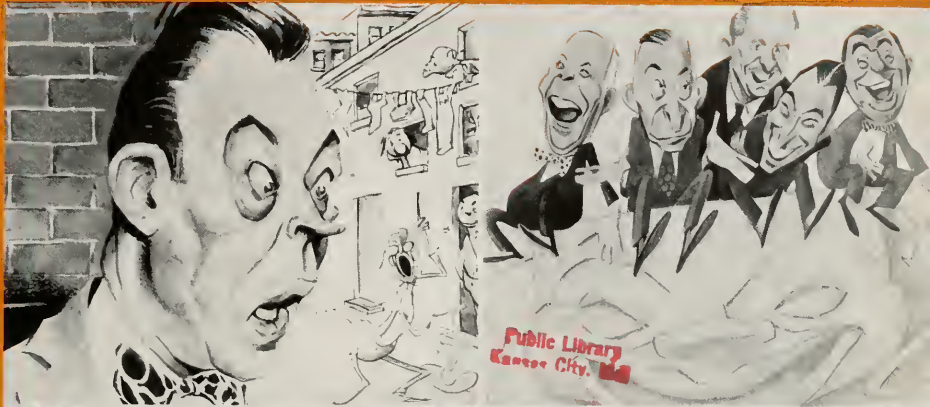

OCTOBER

1947



*Ultrasensitive RCA television camera tube cuts studio light requirements 90%*

**Television finds drama in the dark  
— with new RCA studio camera**

Now television becomes even more exciting as lights are dimmed, and the camera reaches deep inside studio shadows to capture action as dramatic as any on stage or screen . . .

A new studio television camera—developed by RCA scientists and engineers—needs only 1/10th the usual light.

The super-sensitive eye of the new camera is an improved Image Orthicon Tube . . . of the type once used only for broadcasts of outdoor events. With it, studio broadcasts now become sharper, clearer—and since so little illumination

is needed, heat in the studio is sharply reduced. No more blazing lights!

Such improvements come regularly from research at RCA Laboratories, and apply to all branches of radio, television, electronics, and recording. These improvements are part of your purchase of any product bearing the name RCA, or RCA Victor.

When in Radio City, New York, be sure to see the radio and electronic wonders at RCA Exhibition Hall, 36 West 49th St. Free admission. Radio Corporation of America, RCA Building, Radio City, New York 20.

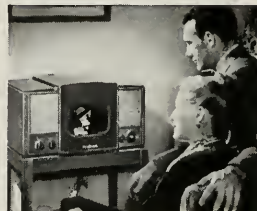

RCA Victor home television receivers bring you every dramatic detail that the new camera catches. RCA's "Eye Witness Television" locks pictures in tune with the sending station. Let your dealer demonstrate.



**RADIO CORPORATION OF AMERICA**

[www.americanradiohistory.com](http://www.americanradiohistory.com)







**Lt. General James Guthrie Harbord, 1866 - 1947**

“... His keen mind, exceptional ability and clear judgment, combined with his high sense of honor, commanded the respect of all those associated with him, and the memory of his kind and lovable qualities and sterling character will be an abiding inspiration to all who enjoyed his friendship.

“By virtue of his preeminently successful and honorable discharge of the duties of high national and international offices, he enjoyed and richly merited the admiration of the public and the deep affection of a world-wide circle of friends.”

# Television Progress

*New Industry Moving Ahead Rapidly and is Destined to Become One of America's Major Industries, Brig. General David Sarnoff Tells NBC Affiliates at Atlantic City Convention.*

**I**N SPEAKING of television for the past twenty-five years or so, we have been accustomed to say that "television is around the corner." In my observations today I should like to bury that phrase. Television is no longer around the corner. It is beyond the doorstep; it has pushed its way through the door into the home!

I would like to go into the subject directly and with a few timely and conservative figures. They will help to illustrate the general remarks I will make about the possibilities of television as a new industry and as an important new service to the public.

The Federal Communications Commission has authorized to date a total of 69 television stations, and 16 applications are pending. This means that 85 television stations already have decided to lead the way. I believe that many more will follow. Today there are 13 stations on the air with regular television programs. By the end of 1947 this number may be doubled. In 1948, the list of stations will increase as

transmitting equipment becomes available.

My estimate is that by the end of 1948 there will be approximately 50 television stations on the air in this country with regular programs. There may be more.

## *Television Receivers*

All kinds of figures have been mentioned about television receivers, and here is my estimate: between 150,000 and 175,000 receivers will be in use by the end of 1947. By the end of 1948, I foresee a total of 750,000. This means that for 1948 our estimates are approximately 600,000 above the number that will have been installed at the end of the present year.

Surveys have been made of the number of people within range of present television programs. Approximately 30,000,000 people live within the areas covered by current television broadcasts. By the end of 1947, this figure will be 40,000,000 and thereafter this audience will be augmented by many millions.

Surveys indicate that seven viewers constitute the average audience at each television receiver. Therefore, if you multiply 750,000 by seven you will see that by the end of 1948 there will be a large audience for television — somewhere near 5,000,000.

The broadcaster must build his own television circulation as does a new magazine or newspaper. That is the broadcaster's job. He cannot toss that responsibility to the television set manufacturer, any more than the magazine or newspaper publisher can transfer his problem to the printer.

A newspaper or magazine spends a substantial part of its initial investment in building circulation; the job of the broadcasting stations, likewise, must be to build circulation in television.

## *Sound-Sight Broadcasting Fused*

I have previously advanced the idea that sound and sight broadcasting will in due course combine. I repeat that thought now. The fusion of sound broadcasting with television is destined to come in radio ultimately, just as the combination of sight and sound took place in motion pictures. Indeed, the time may come when an important broadcast program that we cannot see will seem as strange as a movie we cannot hear. This does not mean that such development is around the corner.

Programs limited to sound and prepared through the techniques of sound broadcasting alone will continue to serve millions of people through many hours of the broadcasting period when the eye cannot be concentrated on the television picture. We must expect that these



GENERAL SARNOFF ADDRESSING NBC CONVENTION AT ATLANTIC CITY ON "TELEVISION PROGRESS."

services will continue to grow and to supplement each other. Therefore, during the years of transition, it seems to me, there will be ample opportunity for broadcasters operating AM and FM receivers to do a substantial volume of business and to render a vitally necessary public service.

### *Local Television*

I should like to say a few words about local television before entering into a discussion of national service. Television programming can be started by local stations in a small way with a minimum of facilities and expanded as receiving sets and commercial sponsors increase. In the meantime, until nation-wide networks are available, film of live shows and newsreels can be flown to stations throughout the country to add to their program variety.

Like the many independent local broadcasting stations which are successful and profitable, television stations also can thrive upon local talent and community service. There is no end to local program possibilities, for the small town is a natural television stage. People like to see their friends and neighbors on the screen. I can foresee many uses for television in religious and educational activities. Television can be a great aid to good government in city, town and county by making citizens better acquainted with their local leaders and their work.

### *Effective Means of Advertising*

Local merchants will find television an effective means of advertising. Dramatic groups, county fairs and community sports events will enlarge their audiences. Often a local baseball or football game or a prizefight is as interesting to a community as a professional sports event in a distant city. Civic and fraternal organizations and women's clubs also are sources of programs for local television stations.

You can imagine the interest that would be shown in a local community if, for example, one or more department stores were the scene of a shopping hour in the morning or afternoon. The television cam-



"MANY WELL-KNOWN RADIO ARTISTS WILL ADAPT THEMSELVES TO TELEVISION AS SUCCESSFULLY AS THE ARTISTS OF THE SILENT SCREEN ADAPTED THEMSELVES TO THE TALKIES."

era would show the merchandise and the shopper at home could see what each store had to offer before she left home for her marketing. I should think that this would be an interesting experiment in advertising.

### *Network Television*

Automatic relay stations, either alone or in combination with the coaxial cable, show great promise for speeding extension of television program service throughout the nation. Radio relay stations are now in operation between a number of cities, and others are being erected. Eventually these microwave channels will reach out further to connect additional communities in television network service, especially cities not reached by coaxial cables.

Doubtless you have heard about the experiments being conducted from time to time with coaxial cables and radio relays which can carry not only television, but ordinary speech, telegraphy at high speeds, and of course FM and television programs. Because these new cables and relays can handle several services simultaneously, they will be completed, I believe, sooner than we expect. I should not

be surprised, if it is possible to have a television coast-to-coast network within the next few years.

In considering home television, we must recognize that good programs are the master key to public acceptance of the art. Television's popularity, as well as its speed of advance, will be governed by the caliber of the shows. That is the important responsibility of the broadcaster. The success of television and the popularity of the video station will depend upon it.

### *Problem of Talent*

The telecaster will, of course, have the problem of talent. He cannot depend solely upon the radio, motion pictures, and other established sources of entertainment for his performers. Television is a new art form that calls for new techniques and for the development and encouragement of new talent to supplement present radio entertainers. Many well-known radio artists will adapt themselves to television as successfully as the artists of the silent screen adapted themselves to the talkies.

News and sports already have proved natural drawing features for television. Films also will play



an important part in the flexibility of television programming. But timeliness is the great advantage which television has over all other forms of visual entertainment. Those who recently watched the American Legion Parade in New York, the Davis Cup tennis matches, and big league baseball games throughout this summer, can attest to this. News associations are studying methods of television news service to supplement the service they now perform for sound broadcasting. The presidential nominations and election in 1948, with political candidates competing for public attention, will stimulate public interest in television on a widening scale.

It is an interesting fact that broadcasting received its first real impetus in 1920, when the Harding-Cox election returns were broadcast and picked up by amateur stations. It was the presidential election that really put broadcasting in the news and stirred public interest. Then came the Dempsey-Carpentier fight in 1921, which gave tremendous impetus. And strangely enough, the same factors are asserting themselves in these early days of television.

Recently, there have been several

extraordinary demonstrations, one this week, which you perhaps read about in the press: several surgical operations at the New York Hospital were televised by RCA, enabling those attending the American College of Surgeons Congress to view the operations on television screens in the Waldorf-Astoria. Television may prove to be the Medical Lecture Hall of the future. A prominent surgeon remarked, "This is a teaching medium that surpasses anything we have had in the past—I never imagined television could be so effective until I actually saw it!"

#### *Opens New Field*

In still another field, the U. S. Navy recently announced success in underwater television experiments in which RCA equipment is used. This opens an entirely new field in deep-water investigations and novel television programs. Fishermen may use television to locate schools of fish and oyster beds. Explorers can scan marine life on the ocean floor as well as wrecks, by lowering television cameras into the sea. Submarines may yet be equipped with television eyes.

You may have observed recent

announcements of revolutionary progress in radio communications—only yesterday in Chicago I spoke before a meeting of the United States National Commission for UNESCO and reported that RCA within a short time will demonstrate in Washington, D. C., a new system of communications known as Ultrafax. It is a combination of television and facsimile. Ultrafax uses a television station for transmitting printed matter and messages, maps, books, documents, letters, drawings, balance sheets, etc. This new system can transmit and receive at the rate of one million words a minute. I used to think, in the days when I was a wireless operator, that if an operator could send 35 to 40 words a minute and keep it up for eight hours, it was quite an accomplishment.

Now by the Ultrafax system, a 500-page book can be sent from New York to San Francisco in half a minute, and a Sunday metropolitan newspaper, including the comics, in one minute. A single circuit could carry the equivalent of forty tons of airmail, coast-to-coast, in a day. So we have something here that may dip into the mail bag. We may have a radio mail system!

All of this may give you an indication of the march of science and a picture of the important place which a television station in the future may occupy in the community.

#### *International Television*

Today, international television may seem far off. But let us recall that five years after sound broadcasting started as a nation-wide service, we had international broadcasting. While the technical problems of international television are more difficult to solve, nevertheless I believe we shall achieve international television in about the same period of time. The scientific knowledge for doing the job exists. In fact, I know of no problem in international television that money cannot solve.

Television will reach the home by radio as free to the audience as broadcasting is now. A proposed system of so-called wired "phone-vision" would introduce a monopoly



"I CAN FORESEE MANY USES FOR TELEVISION IN RELIGIOUS AND EDUCATIONAL ACTIVITIES. TELEVISION CAN BE A GREAT AID TO GOOD GOVERNMENT . . . BY MAKING CITIZENS BETTER ACQUAINTED WITH THEIR LOCAL LEADERS AND THEIR WORK."



"TIMELINESS IS THE GREAT ADVANTAGE WHICH TELEVISION HAS OVER ALL OTHER FORMS OF ENTERTAINMENT."

feature into television by limiting its service to telephone subscribers only. Such a system, which would further limit its service only to those who would agree to pay for the programs as well as for the receivers, is an idle dream. The political implications, the legal and regulatory aspects as well as the technical difficulties of preventing non-payers from receiving the same programs doom such an impractical system from the start. Moreover, the idea is not in keeping with the traditional American policy of "Freedom to Listen" and "Freedom to Look." These are the principles upon which our country's broadcasting is founded and under which it has developed and prospered.

#### *Manufacturing and Broadcasting*

I should like to digress a bit to make an observation regarding a statement I have heard from time to time which implied that it is sinful for a company to be interested in both broadcasting and manufacturing. The truth is that manufacturing interests have been largely responsible for the development of television and have provided broadcasters with new opportunities for service. If it were not for research,

engineering and manufacturing, there would be no broadcasting, either sound or sight.

Therefore, I feel that while a broadcaster should not be criticized for confining his activities to broadcasting or a manufacturer for confining his operations to manufacturing, nevertheless, where both are conducted by the same organization, the art and industry are advanced rather than retarded. Years of experience have amply demonstrated this to be a fact.

The 25-year period of experimentation and development of television has been full of difficulties. It has been an extremely complex new science and art to establish in the laboratory, the factory, and on the air. The scientists, research men and engineers have done heroic work, for which all of us will ever be indebted.

#### *Television as a New Industry*

Television is moving forward rapidly and is destined to become one of the major industries of the United States. In addition to serving the home, television has application to the theatre, the motion picture studio and the entertainment film. In the manifold processes of industrial life, television

also is destined to play an important role.

The possible size of the television industry is indicated by the following figures: in the first two years of sound broadcasting, that is, 1921 and 1922, the sales of receiving sets amounted to approximately \$100,000,000. In those two years, more than 500 broadcasting stations were on the air.

Now, for the first two full years of postwar television operation, namely, 1947 and 1948, with approximately only ten per cent as many stations on the air, that is 50 instead of 500, it is estimated that the public, during this two years period of television, will spend approximately \$375,000,000 for receiving sets—\$375,000,000 in television, as compared to \$100,000,000 in sound broadcasting. This does not take into account the additional expenditures on television transmitters, the cost of erecting and operating them and the cost of programs. Therefore, in round figures, within a year and a half or so from the present time, we shall approach a \$500,000,000-a-year industry in television. And that will be only the beginning. As time goes on, I am confident the industry will grow substantially.



Television will be supported by advertising, both local and national, for it is an ideal advertising medium, unsurpassed in its simultaneous appeal to the eyes and ears of many millions of people. Studies indicate that the pulling power of advertising on television is many times that obtainable by sound broadcasting alone.

#### *Television as Advertising Medium*

Television is setting a much faster pace as an advertising medium than broadcasting did in its pioneering days of the early 20's. It is apparent that sound broadcasting soon will face keen competition from television. As television expands on a national scale, this competition is certain to increase.

It seems to me that broadcasters should not consider television solely from the standpoint of profits or losses during the pioneering period. We must look to the opportunities ahead and weigh the obligation which all of us share to render maximum service to the public.

There are other important eco-

nomie considerations, which must not be overlooked. As the television audience increases and programs improve—and both results are sure to be achieved—many listeners are bound to switch from sound broadcast to television programs. I do not mean that they will switch permanently from sound broadcasting to television, but they will be switching back and forth between these two services. They cannot enjoy both at the same time unless sight and sound are combined in all programs. As the switching goes on, it will reduce the audience of sound broadcasting stations and increase the audience of television broadcasting stations. Those who are not in television will find their sound broadcasting revenue, which is based on circulation, diminished. That fact is self-evident.

To maintain their present position in their local communities, to render the greatest possible service and to safeguard the capital investments and earning capacities of established sound broadcasting stations, prudent owners will consider

television as an added new service, vitally necessary to insure their existing business against reduction of audience, loss of profits and depreciation of investments.

#### *A Message to Broadcasters*

Affiliates of the NBC: This is the message I should like to bring to you. I do not want to ask you to buy television stations, or to erect them, or to urge you to enter television beyond your own convictions, or to promise you immediate profits. But I feel that I should be less than frank if I did not on this occasion, particularly when you are all assembled, share with you the thoughts I hold, not only about the future possibilities of television—and my enthusiasm is unlimited as to that—but also about the possible effects that television may have upon the present broadcasting business.

I have lived through several periods of development in the fields of communications and entertainment. I remember the day when wireless as a service of transoceanic communication was regarded by some as a joke. In the days when I worked as a wireless operator, a cable company could have acquired the Marconi Wireless Telegraph Company of America for only a few million dollars. Those who owned the cables could not see wireless as a competitor of cables. Who, they asked, would send messages that were not secret through the air? Who would entrust important messages to a service that was filled with static?

Today, the law says to the Western Union: "You must divest yourself of the cables." But now it is difficult to find a buyer for cables. Today, radio is the modern method of international communications, and can reach every country directly.

I lived through the day when the Victor Talking Machine Company—and those who founded it did a great job in their day—could not understand how people would sit at home and listen to music that someone else decided they should hear. And so they felt that the "radio music box" and radio broadcasting were a toy and would be a passing fancy. What was the result? Not

"NEWS AND SPORTS ALREADY HAVE PROVED NATURAL DRAWING FEATURES FOR TELEVISION. THOSE WHO RECENTLY WATCHED THE DAVIS CUP TENNIS MATCHES CAN ATTEST TO THIS."

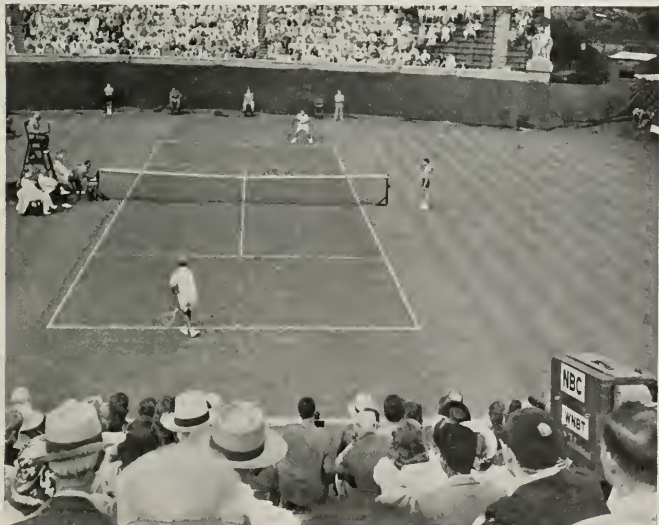

many years after their fatal dream, RCA acquired the Victor Talking Machine Company, and the little dog changed its master.

I saw the same thing happen in the field of talking motion pictures. It was argued by many that people would not go to a movie that made a lot of noise and bellowed through an amplifier and disturbed the slumber of those who enjoyed the silent movie. That, they said, was a preposterous idea! The very virtue of the silent movie, they contended, was its silence! And then—in 1927—came Warner Brothers with “The Jazz Singer” and Al Jolson. Almost overnight a new industry was born. The silent actor became vocal, and the silent picture was given an electronic tongue. Today, who goes to a silent movie?

#### *Radio Has Stake in the Present*

Now, I should like to impress upon those of you engaged in radio, that for the first time in its history, radio itself has a stake in the present. It must be careful not to act like the cable company, the phonograph company and the silent motion picture company, which looked upon the new children of science as ghosts of obsolescence that might adversely affect their established businesses. In their desire to perpetuate and to protect their existing businesses, some of them stubbornly resisted change and progress. Finally, they suffered the penalty of extinction, or were acquired by the progressive newcomers.

Let me assure you, my friends,

after more than forty years of experience in this field of communications and entertainment, I have never seen any protection in merely standing still. There is no protection except through progress. Nor have I seen these new scientific developments affect older businesses, except favorably, where those who were progressive, gave careful thought and study to the possibilities of new inventions and developments for use in their own business.

#### *A Stimulant in the Theatre*

Despite the fact that the Victor Talking Machine Company passed into radio hands, more phonograph records are made and sold today than ever before. And so it is with the entertainment industry. Talking pictures saved that industry at a time when it needed saving and has kept it prosperous ever since. Television in the theatre may be as much of a stimulant to an industry which at the moment, at least, needs a new stimulant, as sound was to the silent movie.

Therefore, may I leave you with this final thought: I am not here to urge you to enter the field of television beyond the point where you yourselves think it is good business for you to do so; nor to propose that you plunge all at one time. Rather I would suggest that you reflect carefully and thoughtfully upon the possible ultimate effects of television upon your established business if you do nothing, and of the great opportunities for your present and future business if you do the right thing!

## JOLLIFFE ELECTED DIRECTOR OF RCA

*Head of Laboratories Division  
Joined Company in 1935*



DR. CHARLES B. JOLLIFFE

Election of Dr. C. B. Jolliffe, Executive Vice President in Charge of RCA Laboratories Division, to the Board of Directors of Radio Corporation of America was announced by Brig. General David Sarnoff, President and Chairman of the Board, on September 5, following a meeting of the Directors.

Dr. Jolliffe joined the Radio Corporation of America in 1935 as engineer-in-charge of the RCA Frequency Bureau. He was appointed chief engineer of RCA Laboratories in 1941, and early in 1942, he was made Assistant to the President of RCA. In September 1942, he became Vice President and Chief Engineer of the RCA Victor Division. On March 2, 1945, he was elected Vice President of Radio Corporation of America in charge of RCA Laboratories, and on December 7, 1945, he became Executive Vice President in charge of the same division. He was awarded a Ph.D. in 1922 at Cornell University, where he was instructor of physics from 1920 to 1922.

“MORE PHONOGRAPH RECORDS ARE MADE AND SOLD TODAY THAN EVER BEFORE.”





# SURGERY TELEVISED

*Thousands of Surgeons Attending New York Convention Witness Operations by Television in Viewing Rooms a Mile from Hospital.*

FOR the first time in the long history of medicine, the skills of the country's best known surgeons have been closely observed by members of the medical profession at "clinics" remote from the hospital operating theatre. This epoch-making demonstration was conducted during the recent Congress of the American College of Surgeons at the Waldorf-Astoria hotel, when RCA television successfully linked the New York Hospital on East 68th Street with viewing rooms at the hotel, a mile away. The experimental broadcasts were carried out as an indication of the possible application of television to surgical education.

To make the demonstration possible, RCA Victor installed an Image Orthicon television camera on a specially constructed track above the operating table. This arrangement permitted the camera to be moved as required to obtain the best view of the operative procedure. The normal lighting of the operating room was ample for the Image Orthicon camera. As the surgeons worked, their running

commentaries were broadcast together with the images.

Pictures were transmitted from the hospital to the hotel by means of a highly-directional television relay link. Because of the narrowness of the line-of-sight beam and the very high frequency used for the transmission, the programs could not be picked up by standard television receivers.

A cable carried the signals from



EVERY MOVE OF THE SURGEON IS PICKED UP BY THE IMAGE ORTHICON CAMERA SUSPENDED OVER THE OPERATING TABLE.



THIS PARABOLIC ANTENNA ATOP THE WALDORF-ASTORIA HOTEL INTERCEPTED THE TELEVISION SIGNALS TRANSMITTED FROM THE NEW YORK HOSPITAL, A MILE AWAY.



SURGEONS ATTENDING THE AMERICAN COLLEGE OF SURGEONS CONVENTION IN NEW YORK WATCH CLOSELY AS TELEVISION SCREENS BRING CLOSE-UPS OF OPERATIONS TAKING PLACE AT THE NEW YORK HOSPITAL.

the camera to the microwave radio relay transmitter on the roof of the hospital. From there, the antenna, which was shaped like a parabola, directed the signals to a similar receiving antenna on the 18th floor of the Waldorf-Astoria.

For the convenience of the surgeons, seven RCA Victor television receivers were installed in the Perroquet Suite on the fourth floor of the hotel. Seating facilities accommodated about 300 at a time. Two additional receivers were installed at the hospital. One was placed in the operating room, to enable the operating surgeon to see the operative area covered by the camera; the other was in an adjoining office for the benefit of the hospital staff.

Operations selected for the television clinics included a hernia re-



pair, a thyroidectomy, a gall bladder removal, and a stomach resection.

After witnessing this contribution of electronic science to medical education, surgeons were lavish in their praise.

Dr. Arthur W. Allen of Boston, president of the American College of Surgeons, said:

"This is a teaching medium that surpasses anything we have had in the past. I never imagined that television could be so effective until I actually saw it demonstrated here."

Declaring that this use of television "greatly extends the teaching value of the hospital clinic," Dr. Malcolm T. MacEachern, Associate Director of the American College of Surgeons, said: "This is a wonderful development; we are enthusiastic over its potentialities."

### *Surgeon Praises Experiment*

He hailed the experiment as "a conspicuous example of the way in which advances in the technical arts can be applied to speed progress in medical science and education for the benefit of the patient.

"I think we have been privileged to stage this week," Dr. MacEachern added, "an event that will go down in medical and technical history. Clinics, operative and non-operative, in the hospitals are the principal means of visual education in surgery. Obviously, the accommodations in the operating room for observation, even in a great medical center like New York, are limited compared with the number of surgeons who wish to attend.

"For some years we have supplemented the clinics with surgical motion pictures. This year, for the first time, another supplementary device is being employed—namely, television, which permits surgeons in the headquarters hotel to see operations in a nearby hospital as they are being performed.

"We are grateful to the RCA engineers for their ingenuity in adapting television to surgical education."

The televised operations were made possible by the cooperative efforts of The New York Hospital, the American College of Surgeons, the Johnson & Johnson Research Foundation, and RCA.



BRIG. GENERAL DAVID SARNOFF AND LUDOVIC CHANCEL, FRENCH CONSUL GENERAL IN NEW YORK, WHO PRESENTED CROSS OF THE COMMANDER OF THE FRENCH LEGION OF HONOR TO RCA'S PRESIDENT AT THE WALDORF-ASTORIA HOTEL ON SEPTEMBER 23.

## France Honors Sarnoff

*RCA President Receives Legion of Honor Medal for his "Distinguished Services" in War and His Contributions to Radio.*

AT A CEREMONY and reception given in his honor at the Waldorf-Astoria Hotel on September 23, Brig. General David Sarnoff received the Cross of the Commander of French Legion of Honor, presented by Radio France and its American subsidiary, the American Radio Company.

In presenting the decoration, Ludovic Chancel, French Consul General in New York, announced that it was awarded in recognition of General Sarnoff's "distinguished services in France as an officer in the Supreme Headquarters, American Expeditionary Forces; his re-establishment of communications circuits following the liberation of the French Republic, and his outstanding work during more than thirty years in building friendly relations and understanding between the peoples of America and France."

Arnold Haase-Dubosc, President of the American Radio Company, praised General Sarnoff for having

"worked tirelessly toward the goal that the original discoveries of the pioneers in electronics might remain an instrument of peace and an effective arm in the cause of freedom." He said that during the painful invasion of France, General Sarnoff's appeal for the freedom to listen had "won the hearts of the French people."

Other speakers at the reception included Maurice Boyer, Chairman of the Board of the American Radio Company, and Mme. Genevieve Tabouis, noted French newspaper writer and wife of the President of Radio France. Approximately two hundred guests attended the reception in the Le Perroquet Suite.

General Sarnoff had received two decorations previously from the French Government. On February 15, 1935, he was awarded the Cross of Chevalier of the Legion of Honor, and on June 6, 1940, he was presented the Cross of Officer of the Legion of Honor.



POPE PIUS XII POSES FOR THE TELEVISION CAMERA AND WATCHES THE RESULTING IMAGE ON A RECEIVER AT ONE SIDE OF THE OPERATOR.

## U. S. TELEVISION IN ITALY

*RCA Video Equipments Displayed at Milan Fair and Demonstrated to Pope Pius XII in Vatican, As Part of Marconi 50th Anniversary Celebration.*

**A** VERY old and very new culture met and merged for a few weeks when the RCA International Division made arrangements for a visit of RCA Victor's roving television equipment to Italy.

During our stay in that country we televised the important Milan Sample Fair, equivalent to a World's Fair here, participating with singular appropriateness in the Marconi Day ceremonies. We televised ballet and opera at the beautiful old La Scala Opera, well-spring of much of the world's musical culture. We presented a special series of broadcasts for Premier Alcide di Gasperi, Prime Minister of Italy, and his guests at the offices of RAI (Radio Administration Italia). And, probably most impressive of all, we enjoyed the gracious hospitality of the Vatican when we presented a special broadcast for His Holiness Pope Pius XII at Consistory Hall. Everywhere we found surprises and new ideas about television programming.



By Richard H. Hooper  
*Promotion Manager  
RCA Victor Division*

Arrangements for the RCA Exhibit at the Milan Fair, which also included other RCA electronic services and products, were made by G. A. Biondo, President of the Telson International Corp., RCA distributor in Italy.

Our crew included Joseph A. Jenkins as Director; Chester E. Davis, Chief Engineer; Edward K. Price and John H. Roe, engineers. They left La Guardia Airport Marine

Base May 26, landing at Gander, Newfoundland; Shannon, Ireland, and Geneva, Switzerland, before taking the three successive trains necessary to reach Milan. I came along a few days later. In my luggage was an electronic viewfinder for one of the RCA Image Orthicon cameras we used. In the last minute rush there was no time to declare it, so it was brought along almost as a gamble. When our train reached the town of Domodossola, just across the Italian border, customs inspectors came aboard and, with instinct like a bird dog's, they pounced upon the suitcase carrying the viewfinder. When they opened it and saw the intricate-looking electronic gadget, reinforcements were brought in and I had visions of spending my days in Italy in some dark prison. Fortunately, the linguistic ability of a French perfume company executive I'd befriended on the train persuaded them to seal and impound the suitcase and bring it to Milan where our efficient representatives assisted me in reclaiming it.

### *Programs from La Scala*

Since La Scala was to be the source of some of our most important broadcasts for the Milan Sample Fair, we found it advisable to set up much of our equipment there. La Scala was one of the most inspiring experiences we had because there, in culture-loving Italy, we saw what devotion to superior entertainment can mean. As soon as the war was over for the people of Milan, laborers volunteered to work on their opera house almost before they repaired their own homes. From all over the city they "liberated" building materials. Children with only a few lira to buy milk contributed part of their funds to the reconstruction of La Scala. By the time we arrived, the building looked almost exactly as it must have appeared before it was damaged by bombing. Only the library of original manuscripts which had been burned had not been replaced.

[RADIO AGE II]

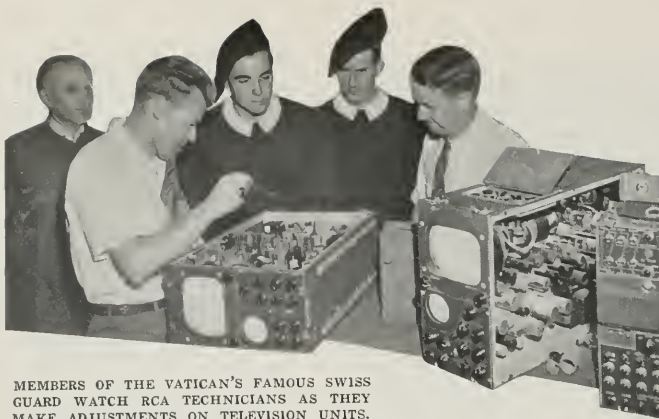

MEMBERS OF THE VATICAN'S FAMOUS SWISS GUARD WATCH RCA TECHNICIANS AS THEY MAKE ADJUSTMENTS ON TELEVISION UNITS.

As Ed Price stood on the roof of the building one day, getting ready to set up the antenna, an Italian workman approached him and excitedly dropped his load to explain with words and gestures that Ed should move over—but slowly. Later he indicated that Ed could stop. Then he gingerly made his way to where the RCA engineer had been standing and jabbed a pointed stick through the roof. Only four thicknesses of tar paper had supported the weight of the man and his equipment. Directly below— a drop of some 300 feet— was the stage of the opera house.

#### *Eleven Receivers in Equipment*

The television equipment we had brought along included two RCA Image Orthicon cameras capable of operating under all the lighting conditions we would be likely to encounter, other standing remote pick-up equipment including relay facilities and ten RCA Victor 630TS, 10-inch table model television receivers, plus one of RCA Victor's new 648 PTK receivers showing the bright, 15 x 20 inch, big-screen picture. This ultra-modern gear was hauled from customs to the Auditorium of the Marconi Building by horsecart. The relay link was set up on the roof of the tall Sports Palace. At the main Auditorium, where the largest crowd would be gathered during our visit, we set up most of the television receivers. The rest of the receivers, including the 648 PTK, were set up

along with a wide range of RCA's other advanced products at the Marconi Memorial Building. An FM transmitter, an induction heating exhibit, a tube display and marine radio were among the products shown here in the building dedicated to Marconi on the 50th anniversary of his sending that first historic message across the Atlantic.

In La Scala, one of the Image Orthicon cameras was mounted in the Royal Box, the other on the second tier near the stage. The control equipment was set up in a room behind the Royal Box.

In the process of televising live music without restrictions, we were afforded an excellent opportunity to discover much about what to expect when arrangements are made for American broadcasters to incorporate live music into their programs. We learned, for example, that some of the operas, as they have been staged down through the years, will benefit from the more plastic and flexible lighting and the dramatic implications of mood variations which flexible lighting can bring about. "Rigoletto" and "Orpheus", as presented at La Scala, were too dimly and uninterestingly lighted to make good television fare. Other fine music, including opera, ballet and concerts, were superb for television programming, with camera movement and selectivity doing much to arrest and retain audience interest in the entire performance. This was attained by use of the various turret mounted lenses and

by carefully selecting segments of the action.

We televised "Madame Butterfly" and "La Traviata", finding that the television camera could do much to help convey the meaning of the operas and help observers feel more aware of the emotional messages of the artists. "Coppelia", "Invitation to the Dance", "Three-Cornered Hat" and "Bolero" were ballets our crew televised at La Scala. Here, again, we found that television could contribute to the arts in addition to extending their audiences. Our crew became familiar with the dances during rehearsals. Then, we took the premier danseur's more magnificent leaps, and close-ups of the varying centers of interest, such as the ballerina, and we followed the action with flexible camera movement, all interspersed with long orientation shots. Thus we were able to fall into the spirit of the performance and, according to some of the critics who saw the show, help television partake of and contribute to the over-all enjoyment of ballet.

#### *Official Addresses Televised*

In addition to these shows, we televised addresses by officials of the Italian government, including the Minister of Communications, fashion shows, various radio programs, variety shows, and interviews with ordinary visitors to the fair and many well-known personalities. We had frequent opportunities to demonstrate the equipment to influential people during the visit to Milan. The Mayor and his family, the president of the Fair, U. S. Ambassador James Dunn and Mrs. Dunn and others became familiar with the advances made in television by American industry.

On July 1, we moved from Milan to Rome and the Vatican. Thanks to Count Enrico Galeazzi, Economic Administrator for Pope Pius XII, we had the freedom of the Vatican to make the installation for a special showing of television to the Holy Father. We set up the equipment in the reception hall on long cables so that it could be moved into the Vatican Library quickly.

Wherever we turned, we found interesting information about the Vatican during our few days there.



The ceiling of Consistory Hall, in which the Pope holds sessions with the College of Cardinals, is done entirely in gold frames, each frame enclosing an original mural by Michael Angelo depicting a scene of the world's creation. The gold for the frames came from the first shipment brought over from America in 1493-94. The Swiss guards in full uniform identical with those worn there for centuries, the exquisite art by Michael Angelo, the quiet beauty and awesome dignity of the Vatican, all helped make the visit memorable to every member of our crew.

### *Special Program for Pope*

On July 9, after carefully checking all gear and rehearsing with the Vatican chorus of 13 male voices singing ancient madrigals, we presented the special hour-long show. Pope Pius XII entered his chambers at 5:56 P.M., sat in a gold chair before a 630TS television receiver, and, with the original, hand-illuminated manuscript of the music before him, alternately watched the broadcast and followed the original score. The performance consisted of three songs by the Vatican choir from Consistory Hall and scenes of the surrounding countryside, including an observatory on a hill in Rome some five miles away picked up with a telephoto lens. Pope Pius expressed

great interest in the new medium. He speaks flawless English and has the softest voice I've ever heard.

After the broadcast he said, "The quality is astounding. The clarity is phenomenal. Your company is to be congratulated. An exceedingly fine show."

He inspected the control equipment and posed before the television camera, seemingly amused by the fact that he could watch his image on a receiver at the same time. Following the demonstration, he issued a Consistory Memorial Medal to Frank M. Folsom, Executive Vice President of the Radio Corporation of America in Charge of the RCA Victor Division, through whose offices arrangements for the demonstration were made, and also to each of us representing RCA at the Vatican.

### *Cameras Set Up in Record Time*

Our next stop was at Rome where, on July 12, we were to present a special broadcast for Premier Alcide de Gasperi, Prime Minister of Italy and Presidente del Consiglio (Council President), and his party, plus officials of R.A.I. (Radio Administration Italia, the Italian radio network), at the latter's offices. The audience consisted of nearly 200 people. Here we were especially grateful for the efficiency with which the RCA remote pickup equipment was designed. We

erected our gear in what, for us, was the record-setting time of 55 minutes! Using a large studio and a control room, we ran cables to six receivers in other studios. We secured power from a 20 kw generator mounted on a truck in the street.

### *Language Barrier Overcome*

R.A.I. supplied the program artists for us, consisting of a harpist, three vocalists, a string ensemble, four models who presented an excellent fashion array, a master-of-ceremonies and an 18-piece orchestra. The latter was nearly to prove my undoing. While our crew's mastery of Italian was, at best, negligible, my knowledge of the language only served to lower the average. Strangely enough, though, we felt perfectly at home here because the radio hand signals familiar to every American broadcaster are also used as another form of international language.

You couldn't help but be impressed with the sensitive, artistic appearance of these musicians. Already we had experienced the high cultural levels attained by the artists at La Scala and the rich, ancient music of the Vatican choir. Therefore, we were prepared for the purest of classical artistry by the orchestra. I gave the leader the stand-by signal. He raised his baton. I pointed my finger at him to start the music. Then he led the orchestra in the hottest rendition of "Tiger Rag" I have ever heard.

The quality of the artists, both classical and contemporary, was excellent and the broadcast was the kind that gives the producer a sense of satisfaction to have had a hand in it.

These shows in a fascinating foreign country, these superb artists, were those that American audiences would enjoy, just as overseas audiences would certainly enjoy watching our television broadcasts.



NATIVE ARTISTS PRESENT SPECIAL PROGRAM FOR PREMIER DE GASPERI IN A STUDIO OF THE ITALIAN RADIO NETWORK, AS TWO RCA IMAGE ORTHONIC CAMERAS FOCUS ON THE SCENE.

# Freedom to Listen and Freedom to Look

*Radio of the Future will be a Combination of These Freedoms, Internationally Enjoyed, General Sarnoff Declared in Address to U.S. National Commission for UNESCO.*

**S**UCCESS in establishing world peace and understanding depends upon who wins "the battle for the minds of men," said Brigadier General David Sarnoff, President and Chairman of the Board of Radio Corporation of America, in an address delivered September 12 at a luncheon sponsored by the Chicago Council on Foreign Relations in honor of the United States National Commission for UNESCO. He was introduced by William Benton, Assistant Secretary of State.

"Since the fighting war ended two years ago," declared General Sarnoff, "another global conflict has started—a battle for the minds of men. Forces of totalitarianism and aggression still are attempting to mislead the masses. Fully aware of the power of radio, they are using it to spread propaganda that runs contrary to peace, freedom and democracy.

"Our American concept of radio is that it is of the people and for the people. Its essence is freedom—liberty of thought and of speech. Our purpose in fostering international broadcasting is to help make the spectrum of radio truly a spectrum of peace.

"By its very nature, radio is a medium of mass communication; it is a carrier of intelligence. It delivers ideas with an impact that is powerful. In the preservation of peace, the electron, which is the heartbeat of radio, may prove more powerful than the atom. In a forum for international discussion and education, the voice of radio can carry knowledge of public issues around the earth and mold public opinion far more quickly and far more effectively than any other means."

General Sarnoff recalled that for more than twenty years he had given thought and study to the subject of international broadcasts embodying the principle of "Freedom to Listen," and that he had the privilege of discussing it on several occasions with President Roose-

velt, Secretaries of State Hull and Marshall and other high officials of the American government and the United Nations. He said that with the advent of television "Freedom to Look" had become as important as "Freedom to Listen," declaring:

## *Television Moves Forward*

"In recent months you have doubtless seen and read much about the progress of television. It is on the way and moving steadily forward. Television fires the imagination, and I can foresee the day when we shall look around the earth, from city to city and nation to nation, as easily as we now listen to global broadcasts. Therefore, 'Freedom to Look' is as important as 'Freedom to Listen' for the combination of these will be the radio of the future. This is no idle dream and no one need doubt that we shall have international television.

"This extension of television is nearer than most people may realize. When nation-wide broadcasting began, it was only five years before listeners overseas were picking up the broadcasts, and before long, regularly scheduled international broadcasts became an established fact. Therefore, in looking ahead, we may reasonably expect that international television will follow much the same pattern of progress. In fact, it may develop more rapid-

ly because the foundation is laid by international sound broadcasting. Already the scientific principles and means for world-wide television are known. No technical problem is involved that money cannot solve.

"May I point out that when I speak of international television, I do not think of it as only between the United States and Europe, Asia or South America, but intracontinental as well; for London may look-in on Paris, Berlin, Rome or Moscow, while their citizens in turn will look-in on London or on other cities of their choice.

"Such television has broad possibilities in portraying the way of life of one nation to another. For example, discussion in the press or on the radio of a food shortage is one way of imparting information, but to be able to see hungry men, women and children in breadlines would help more fortunate people to visualize instantly the dire circumstances and basic needs of their fellow-man."

## *Cost Relatively Unimportant*

While expressing confidence that international cooperation and statesmanship could solve the problems involved, General Sarnoff remarked:

"So far, I regret to observe that very little has been done about it. Yet no one has seriously opposed the idea of an international broad-

**"ALL PEOPLES HAVE THE RIGHT TO KNOW THE TRUTH IN THE NEWS, AND IT IS THE DUTY OF INTERNATIONAL BROADCASTING TO PROVIDE THEM WITH THE TRUTH."**

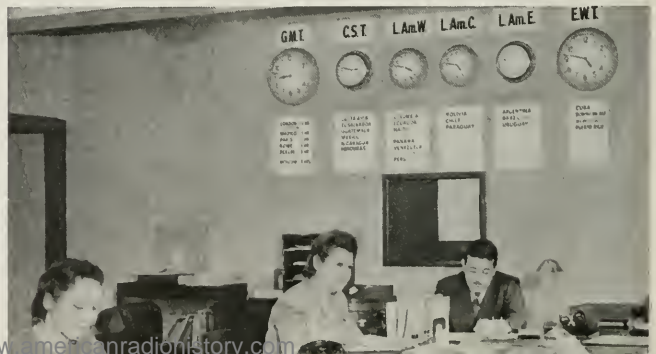



"IT BEHOVES THE UNITED NATIONS TO SPEAK OUT IN ALL TONGUES, CLEAR ENOUGH TO BE HEARD ON LAND AND SEA, ON DESERTS, FARMS AND STEPPES."

casting system based on the principle of 'Freedom to Listen' for all peoples of the world. Such questions as have been raised in some quarters seem to relate primarily to finances.

"If the principle is right, and if the job needs to be done, it is clear, it seems to me, that the cost is relatively unimportant. Even if the cost of operating such a world-wide system should prove to be as much as \$50,000,000 a year, that figure is far less than the cost of one modern battleship; it is a mere fraction of what a single nation spends yearly for its armament. It is less than one-fifth the amount that was spent on fighting in a single day during the last World War.

"Dedicated as it is to the service of all mankind, it is difficult to understand why the question of cost should determine the need of an effective world-wide radio voice for the United Nations. To me, the question is not what other activities justifiably could take precedence over such a project, but what possible activities could be entirely effective without it. In this Atomic Age, the world has gone far beyond the luxury of discussing freedom of communications from a purely ideological standpoint.

"I submit that such freedom is vital to the maintenance of world peace. It is one of the armaments to prevent the next war. It is as important as the provision of any weapon to secure the peace."

This, then, is "no time for whispering, or for mere lip service," General Sarnoff declared, and added:

"The 'Voice of Peace' must be made strong—strong enough to be heard above the tumult that would stifle freedom or kindle the fires of atomic war. It behooves the United Nations to speak out in all tongues; clear enough to be heard on land and sea, on deserts, farms and steppes. Its broadcasts should carry not only information and news, but entertainment and melody as well; for music is a universal language.

#### *Radio Can Spread Truth*

"It is the use to which radio is put that is all-important. Broadcasting and television may function free and unfettered, or they may be muzzled and restricted to the use of a few. Radio can spread truth and untruth with the same speed and over the same range. The choice must be made by man. We saw, during the recent World War and during the years that led up to it, how radio could be perverted by dictators. We have also seen how it was used as the 'Voice of Victory' so effectively that the 'Voice of Aggression' was silenced in the defeat of those who perverted this great tool of science to their own evil purposes."

The address stressed the urgency for America to "do more—much more—than it is doing now in this vital field." It held that the main-

tenance of international short-wave broadcasting from the United States is as important today as it was at any time during the war, with beams aimed to friendly, democratic nations as well as to those whose governments may be unfriendly and undemocratic.

Referring to the State Department's recent discontinuance of broadcasts to Scandinavia as cause for shock to a large and friendly audience, General Sarnoff quoted from a letter which he said epitomized the feeling of dismay, and which he said shed light on many of the problems being studied by the U. S. Commission for UNESCO.

The letter, received by the National Broadcasting Company from a listener in Denmark, said that the broadcasts from America had been a daily reminder of American friendship and interest in helping to reconstruct war-ridden Europe and create a society where freedom would be a reality. It said that the silence of the American broadcasts left the 14,000,000 Scandinavian friends to the mercy of "those other hard, cold and hateful voices from the East." It asked "Has America surrendered?"

General Sarnoff in commenting on the missive said:

"This moving letter from a foreign listener is a dramatic testimony that there is a war in the air today—a battle between truth and falsehood—a battle for the minds of men! American radio must not be silent in its fight for the truth; we must not retreat on the battlefield in space! In the interest of world peace we must help to make it possible for people everywhere to know the truth. Only then can they judge the words and acts of their own governments and leaders.

"Our prestige as a defender of truth must be expanded—not curtailed. It is vital that private enterprise and government alike recognize the challenge to cooperate with each other in the national interest, for international broadcasting does not belong exclusively in the domain of either. It is a task that calls for the brains and facilities of both industry and government, functioning in harmony to make the 'Voice of Peace' heard around the world."



# PASTEURIZING MILK BY RADIO

*By Subjecting Fluid to Higher Temperatures for Shorter Period, Electronics Lowers Bacteria Count and Preserves Flavor.*

**P**IONEERING in the development of radio heating processes, members of the research staff of RCA Laboratories, Princeton, N. J., have succeeded in extending the usefulness of this new application of radio energy to a remarkable number of industries. Success has been achieved in sewing, riveting, welding, case-hardening and tempering; also in dehydrating vegetables, drying penicillin, purification of cereals, pre-heating plastics and baking plywood planes and boats, among other distinctive accomplishments.

This new science of radiothermics, a direct outgrowth of research in high frequency broadcasting, first received notice when it provided a means of speeding production lines during the war by completing in minutes industrial operations that had required hours or even days. Since then it has proved valuable in hastening output and reducing costs in peacetime manufacturing processes.

Study of the problem of milk pasteurization was undertaken by George H. Brown, C. N. Hoyler and R. A. Bierwirth after contact with experienced dairymen who felt that the revolutionary possibilities of radio heat might bring solution to difficulties which had plagued the milk industry for many years.

The investigation made use of previous experience, particularly that obtained at RCA Laboratories in applying radio-frequency heating to dry food products such as cereals and flour for the purpose of purification and the destruction of weevils and weevil eggs. In comparison with milk pasteurization, however, this process was simple and straightforward. Since the infesting objects usually contain more moisture than the bulk of material, selective heating takes place and the mean temperature of the food package need not reach excessive values. For instance, experiments conducted at the Laboratories revealed that a mean temperature of 140°F was sufficient to completely inactivate weevils and eggs in one-pound packages of cereal.

## *Long Treatment Affects Flavor*

On the other hand, in conventional pasteurization of milk, the milk is normally heated to a temperature of 143°F and held at this temperature for 30 minutes. The milk is then cooled for storage or bottling with the bacteria content usually reduced to about 1 per cent of the starting value.

Dairymen explained that if times less than 30 minutes are used the bacteria content is notably greater, whereas a longer time results in a cooked flavor and an apparent reduction of cream volume.

Investigation also was made of flash pasteurization methods in which the milk is heated to 161°F and held for 16 seconds. In some of these experiments the milk is spread on a thin film of heated plates and then quickly pumped over cooling plates. In another process the milk is passed between two electrodes to which 60-cycle voltage is applied. Since the milk is a good conductor, current flows

through the milk and generates heat.

It appears that difficulties with the electrodes have kept this latter method from becoming popular. Nevertheless, this method indicated the advisability of heating by means of electric current to explore the effects to be encountered with temperatures far in excess of 161°F. It was felt that the use of radio-frequency power might make possible the heating of milk in continuous flow with the milk coming in contact only with glass.

## *Current Passes Through Milk*

Seeking to learn the solution of fundamental problems connected with this procedure, a series of experiments were carried out. In the first of these, milk was preheated to 140°F and was then run through a long glass tube, ¼" in diameter. Electrodes wrapped around the glass tube consisted of two pieces of copper foil, causing radio-frequency current to flow from one electrode through the glass to the milk stream and down the milk stream for a few inches. Temperature was measured by a thermocouple inserted below the second electrode.

These experiments showed that excellent pasteurization could be obtained in about 67/1000 of a second though it was not possible to achieve temperatures above 190°F. The tendency above this temperature was to form steam pockets with uneven flow.

Study indicated that this tendency probably was due to non-uniform flow in the tube, wherein the milk stream adjacent to the glass was slowed down by friction and thus raised to a higher temperature than the center of the stream.

In efforts to circumvent this effect, the tube was so arranged as to produce a free-falling stream between the electrodes. With this arrangement, the milk could be heated to 205°F without steaming or breaking.

Using the uniform flow arrangement, experiments were conducted in which bacteriological tests were found to be excellent. The pre-heating was accomplished by causing the milk to flow through tubing of

*(Continued on page 31)*

EXPERIMENTAL PASTEURIZING SYSTEM  
ERECTED IN RCA LABORATORIES DURING  
RESEARCH ON THE ELECTRONIC TREAT-  
MENT OF MILK.

[16 RADIO AGE]

# THE MAGNETRON

*Research on One of War's Marvels, Heart of the Radar, Began at RCA in Early Thirties — Has Many Peacetime Uses.*



By Dr. J. S. Donal, Jr.

*RCA Laboratories,  
Princeton, N. J.*

OF the numerous developments in electronics that attracted public attention during the war, it is doubtful if any single instrument better typifies the significant advances in that field than the magnetron tube. Not only did this tube make possible the radar warning system credited with saving England in the critical days of the blitz but the numerous later forms of radar which proved invaluable to all branches of the armed services, owed their effectiveness in large

part to the magnetron. The tube is expected to find an increasing number of peacetime applications especially in the fields of television, microwave relays, radio heating and of air navigational aid systems.

The magnetron differs radically in appearance from the common type of vacuum tube with which the public is familiar. Basically, it consists of a vacuum-tight cylindrical metal shell or block divided into a number of compartments or "cavities" symmetrically arranged around a central core. The center of the tube is hollowed out to accommodate an oxide coated cathode which serves as the source of electrons. It is the movement and control of these electrons in relation to the cavity entrances, as well as the number and size of the cavities that make possible the generation of high power at very high frequencies.

When the tube is operating, the electrons released from the heated cathode are forced by the electric and magnetic fields to travel in curved paths past openings leading to the cavities. The latter, accurately dimensioned for the desired frequency, act as resonant chambers from which the energy, given up by the electrons, can be withdrawn.

Although the magnetron gained its prominence as an invaluable military weapon, it is not a war-born product. Records show that research on magnetrons by RCA laboratories extends well back into the early 1930's. In 1932—this was eight years before England rushed models of its magnetron to this country for adaptation to large scale production—Dr. E. G. Linder of RCA's research staff had developed a magnetron which was used in our experiments with 10-centimeter radars from 1934 to 1937. This tube also was used in many of the earliest microwave signal generators.

## *First Tube Had Low Power*

At that time, the power that could be handled by this 10-centimeter tube was limited to a few watts, but in 1936, G. R. Kilgore, later of the RCA Laboratories staff, succeeded in developing a magnetron which generated 100 watts of continuous-wave power at 600 megacycles, the equivalent of 50-centimeter waves.

The next objective of RCA scientists was the development of a magnetron that would deliver many kilowatts of power in exceedingly brief pulses. This was accomplished in 1941, using designs similar to those proposed earlier by RCA engineers and by English scientists and the staff of the Radiation Laboratory. This advanced magnetron produced 500 kilowatts of pulsed power at 3,000 megacycles (10-

RIGHT: SUB-ASSEMBLIES SHOWN HERE SIMPLIFY THE CONSTRUCTION OF MAGNETRONS AND ASSURE MORE RELIABLE OPERATION.

BELOW: THE OUTPUT OF THIS 1 KW MAGNETRON IS FREQUENCY MODULATED BY NINE SMALL ELECTRON GUNS WHICH SEND BEAMS OF ELECTRONS THROUGH THE TUBE'S CAVITIES.

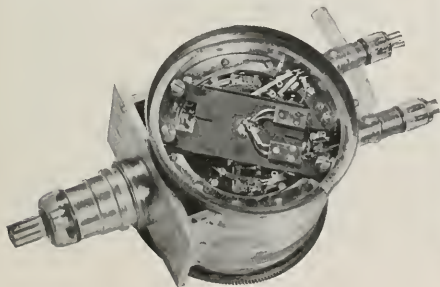
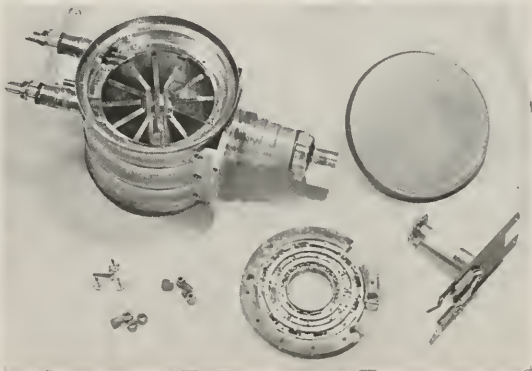

centimeter waves). Impressive as this advance may appear, it was not considered remarkable at the time, since designs for still higher frequencies and power already were well understood.

However, these early tubes possessed one serious drawback. The frequency of the high-power pulses could not be held constant within desired limits.

The first magnetron to have its frequency stabilized by an external cavity, that is, a cavity separate and distinct from the cavities within the tube, was called the 2J41. It operated on 10,000 megacycles, at first rated at 5000 watts peak power, and was intended for service in new light-weight radar equipment. Work on this project was started in 1942 by groups in RCA Laboratories under Dr. V. K. Zworykin and the late B. J. Thompson. In 1943, the Armed Services requested that the tube design be changed to one suitable for use in an ultra-portable beacon project and asked RCA to undertake the development of tubes and equipment under a very high priority.

Tube and Circuit Groups set to work in Princeton, Lancaster, Pa., and Camden, N. J., in cooperation with the Radiation Laboratory of the Office of Scientific Research and Development, in Cambridge, Mass. Dr. B. B. Brown, R. R. Bush, C. L. Cuccia, and the writer adapted their earlier magnetron to the low peak power, high-duty requirements of the beacon project, working with the tube group in Lancaster, which was under the direction of Dr.

Dayton Ulrey, E. E. Spitzer and C. P. Vogel.

The resulting tube was of radical design; it was the first cavity-type magnetron in which all parts were mounted on a plate called the "header" for ease in construction, for light weight and extreme rigidity. Versatility of the electrical design was shown by the fact that the original government request for 50 watts of stabilized peak power was raised progressively to 500 watts yet the tube met the final requirements without change in design.

#### *Frequency Unaffected*

Not only was this tube tunable, but its frequency was practically unaffected by radio reflections from nearby objects and by extreme variations in temperatures such as those encountered at noon in the tropics and in winter night flying at high altitudes. The method of obtaining the maximum degree of stabilization was developed by L. E. Norton, of the RCA Laboratories, working under the direction of Dr. Irving Wolff. During both development and production periods, close cooperation was maintained with the men of the Radiation Laboratory, who contributed their

experience to the initial development and to the production design of tube and stabilizer.

This valuable contribution by RCA was followed by others. During 1944, there was evidence of an increasing need for even more rigid control of the frequency of magnetrons. In addition, there was need for continuous-wave magnetrons which could be frequency modulated. A proposal by Dr. L. P. Smith and Carl Shulman of RCA Laboratories supplied the answer to both control and modulation problems.

The first tube to be developed using the new method of frequency modulation and control was constructed by G. R. Kilgore, Carl Shulman and Drs. J. Kurshan and Rohn Truell of RCA Laboratories. This tube was designed for use in an FM radar project, undertaken for the Navy, which required 25 watts of continuous-wave power at 4000 megacycles. In this tube, employing the header construction of the 2J41, two tiny electron guns, built with watch-like precision, produced spiral electron beams which passed through two of the magnetron resonant cavities. These beams frequency-modulated the tube without affecting the power output. Improvement and further development of the tube is now going on in the Lancaster plant of the RCA Victor Division under the direction of Dr. B. B. Brown. Using this tube, it is expected that wide-band micro-wave relay systems will be feasible at powers many times

*(Continued on page 19)*

THIS CONTINUOUS WAVE MAGNETRON OPERATING ON 4,000 MEGACYCLES IS FREQUENCY MODULATED BY BEAMS FROM TWO TINY ELECTRON GUNS.

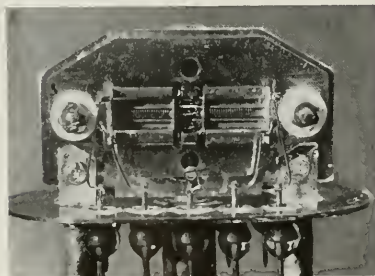

THIS 4,000 MEGACYCLE MAGNETRON CAN BE TUNED FROM THE OUTSIDE WITHOUT AFFECTING THE STABILITY OF THE TUBE.



THE TYPE 2J41 MAGNETRON WAS THE FIRST TO HAVE ITS FREQUENCY STABILIZED BY AN EXTERNAL CAVITY DISTINCT FROM THE CAVITIES WITHIN THE TUBE.

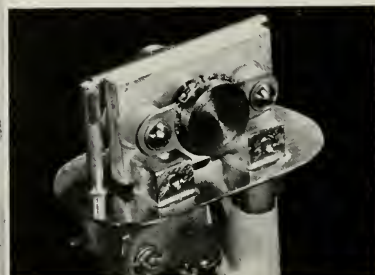





LEFT: GLADYS SWARTHOUT AND HER HUSBAND, FRANK CHAPMAN, LISTEN TO A PLAYBACK OF A RECORDING MADE AT HOME.

BELOW: A SPECIALLY BUILT RADIO-PHONOGRAPH IS ONE OF THE INSTRUMENTS IN THE SWARTHOUT STUDIO.



## Noted Vocalist Studies Roles from Self-Made Recordings

*Gladys Swarthout Installs Recording Apparatus to Aid Her in Preparing for Public Recitals.*

WHEN Gladys Swarthout, one of America's best known mezzo-sopranos, and her husband, Frank Chapman, former concert tenor, had completed the conversion of a barn on their Connecticut estate into an attractive music studio, the first pieces of equipment to be installed in the new quarters were complete phonograph recording and reproducing units, made by RCA.

In assembling their layout, Miss Swarthout and Mr. Chapman first secured a turntable which was designed to operate at either 33 or 78-r.p.m., whether cutting a record or transcribing it. To obtain best results when taking programs off the air for re-recording, they then added a custom-built RCA Victor radio-phonograph. The next and final step was to install a loud-speaker system which would make the music from turntable, radio-phonograph or radio receiver available to listeners in a larger adjacent music room. This was accomplished by installing three cone speakers

high on the music room wall, in such a way that the heavy-timbered walls of the building, acting as a natural baffle, would assure maximum quality of reproduction. When not in use, the speakers are concealed behind a framed painting.

### *Builds File of Recordings*

Since 1942, when the installation was completed, Miss Swarthout has built up a file of several hundred glass-base acetate and lacquer recordings. They represent direct recordings made at a microphone in her studio, off-the-air recordings of her favorite radio programs, and re-recordings of certain musical selections which she wants to retain. She also uses the turntable and cutting stylus to record personal messages and greetings on small disks for mailing to friends.

According to Miss Swarthout, these recording facilities are one of her most valuable aids in preparing concert, radio, recording and operatic repertoires. After record-

ing a selection by means of microphone and turntable, she is able to check on her own interpretation by listening to an immediate playback. This convenience, she adds, is extremely valuable when studying a new composition.

### The Magnetron

*(Continued from page 18)*

higher than those obtainable from presently available equipment.

A second application of the new method of frequency modulation and control was to a continuous-wave magnetron of much higher power but lower frequency. This tube, developed in RCA Laboratories by R. R. Bush, C. L. Cuccia, H. R. Hegbar and the writer, under the direction of Dr. L. P. Smith, was designed for a war project requiring the transmission of medium definition television pictures. Generating more than 1 kilowatt of continuous wave power, the tube is tunable by mechanical means from 720 to 900 megacycles.

Since magnetrons can now be frequency modulated, as well as frequency controlled to any desired degree of precision, they are expected to find wide use at the highest frequencies, for micro-wave relay and broadcasting purposes.

# Metal Detectors in Industry

*Electronic "Sleuths" discover Hidden Particles that Threaten to Damage Machinery and Contaminate Packaged Products.*



By W. H. Bohlke

*Engineering Products Dept.,  
RCA Victor Division*

DAY after day, electronics finds new ways to be useful in industry, emphasizing repeatedly the fact that equipment based upon the action of electron tubes can be made to perform many tasks better and more economically than any other medium. This versatility of electronics is nowhere better evidenced than in the roles now being played by RCA's Electronic Metal Detector as a "sleuth" in the detection of foreign metal particles in manufactured goods, and as a "sentry" to protect costly machinery.

The development of RCA Electronic Metal Detectors has followed an interesting course. In 1933, the company developed a Gun Detector for use in penitentiaries for detecting concealed weapons, hacksaw blades and similar contraband arms. This was succeeded by a variation of the Gun Detector which was produced during the recent war for use at a government arsenal to inspect cartons for remaining bullets.

These early equipments were

constructed of wood, but continued research, carried out during the war for rocket fuel inspection, finally led to the first Metal Detector made of metal. This notable refinement in design was the real forerunner of the stable, flexible and dependable Electronic Metal Detector now available to industry, for high speed, automatic inspection.

Before the RCA Electronic Metal Detector was perfected, many inspection procedures utilized the x-ray fluoroscope. This method has several drawbacks. It requires a dark room where the operator views the x-ray picture of the product; maintenance of the apparatus is expensive; personnel must be protected against leaking x-rays, and state and local regulations governing the operation of x-ray devices must be strictly met. Also, because of the tiresome nature of the work, operators of the fluoroscope system have to be relieved at frequent intervals. Electronic metal detection is not faced with these limitations.

Although a relatively new development in its present form, the

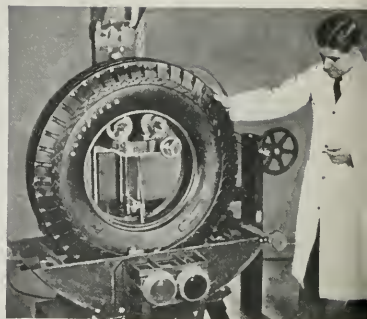

IN THIS TIRE-TESTING MACHINE, ELECTRONICS IS USED TO DETECT FLAWS IN THE STRUCTURE OF THE CASING.

Metal Detector already has been successfully adapted to the candy, food and tobacco fields, insuring finished products that are free from contaminating particles. In these and other fields, where it has been called upon to guard machinery, costly dies, etc., the Detector has soon paid for itself by preventing damage from "tramp" metal of any kind, hidden in the material being processed.

At the Philadelphia candy plant of Peter Paul, Inc., an RCA Metal Detector unit has been in operation 16 hours a day, five days a week, for 14 months, providing depend-

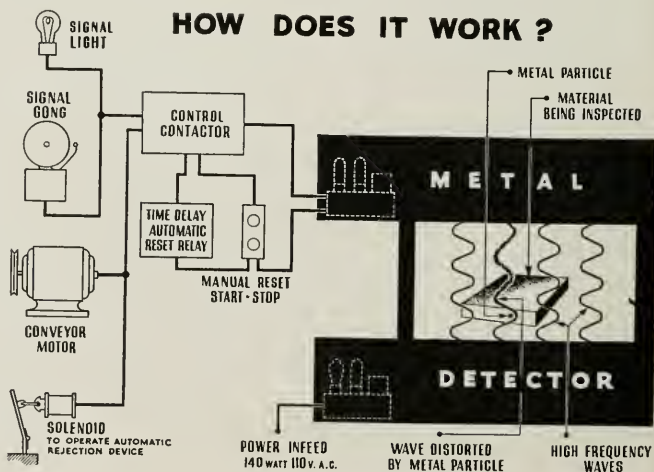

THIS DIAGRAM SHOWS HOW THE DISTORTION OF RADIO WAVES CAUSED BY THE PRESENCE OF HIDDEN METAL PARTICLES IN PACKAGED GOODS, RINGS A BELL TO NOTIFY THE OPERATOR AND SHUTS DOWN THE MACHINE.

able, automatic inspection that simultaneously protects the consumer and the good name of the manufacturer. In this installation, the presence of "tramp" metal in a finished package would automatically ring a bell to notify a nearby employee and, at the same time, stop the belt conveyor. Manual reset is used but automatic rejection could also be applied if desired.

#### *Advantages for Food Processors*

The latest model Metal Detector, through its increased sensitivity, possesses special advantages for food and candy processors. This is proved by the fact that spherical steel particles smaller than this letter "o" can be readily detected. Moreover, the electronic units are housed in a safety-sealed compartment, and the entire Detector may be easily cleaned and even washed down when necessary. The latter features are, of course, very desirable for food and candy plant application.

An interesting variation in the use of electronics for inspection of products is a tire testing machine developed and patented by the Goodyear Tire & Rubber Company for testing tires for air spaces between cords. This machine embodies electronic and mechanical apparatus built by RCA. In operation, the lower portion of the tire is rotated in a wetting tank, the

liquid acting as an efficient coupling means between Detector and controls. If the system detects a flaw in cord construction, a red lamp flashes as a warning to the operator.

When the product to be inspected is sufficiently transparent, such as a bottled soft drink, the combination of light beam and electron phototube can be used to advantage. Foreign objects in the liquid can be detected and the bottles automatically rejected from the conveyor. One equipment has been especially perfected for this purpose by RCA in cooperation with The Coca Cola Company. It is called the RCA Automatic Beverage Inspection Machine for Coca Cola and is now in production.

People interested in Metal Detectors often ask: why are they designed solely for ferrous and non-ferrous metals, when pebbles, splinters and the like have been known to appear in products reaching the consumer. Frankly, a contamination detector that would do a 100% job for any and all foreign materials would not only tax the ingenuity of the industry's most brilliant engineers but the development expense would, in all likelihood, be so great that the cost of the application would preclude its economical use. It is certain, however, that devices of greater versatility will be forthcoming as industry becomes more aware of the

substantial advantages to be derived from a wider use of such equipment.

#### *Protects Quality and Reputation*

Besides being used to protect the quality and good name of a product, there are many instances where the Metal Detector has paid for itself in a short time by preventing damage to processing machinery. For instance, at the RCA Victor record plant at Camden, a Metal Detector, standing guard over the "biscuits" of vinylite plastic from which discs are pressed, saved over \$1200 in a three-week test period by detecting "tramp" metal that would have caused severe damage to matrices or dies.

A similar installation at the National Automotive Fibre Company, Trenton, New Jersey, detected an imbedded broken knife blade during the first three hours of operation. Had the metal gone through the machinery unnoticed, it is estimated that damage to the calendar rolls would have cost \$2,000 to repair.

The "protective" feature also has been found invaluable in the tobacco industry, where razor-sharp shredder knives, rotating at high speeds, can be wrecked by small undetected pieces of metal in the tobacco leaves. Pilot RCA Metal Detectors have been, or are being, installed at the factories of several leading cigarette manufacturers.

FOREIGN OBJECTS IN BOTTLED DRINKS ARE INSTANTLY DETECTED BY THIS ELECTRONIC BEVERAGE INSPECTOR WHICH AUTOMATICALLY REJECTS IMPERFECT PRODUCTS.



CARTONS OF CANDY ON A CONVEYOR PASS THROUGH THE ELECTRONIC METAL DETECTOR FOR FINAL INSPECTION BEFORE SHIPMENT TO CONSUMER.

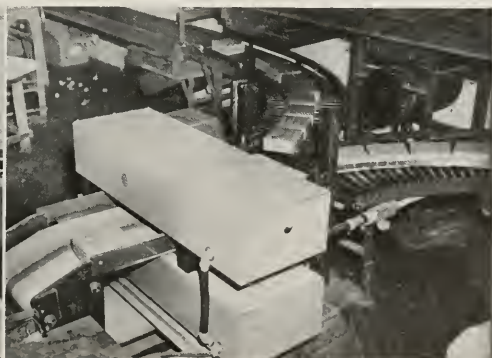





DR. SERGE KOUSSEVITSKY AND THE FAMED BOSTON SYMPHONY ORCHESTRA REMAIN SILENT MIDWAY OF A SYMPHONIC SELECTION AS THEY LISTEN TO THE NEW "BERKSHIRE" MODEL (CENTER REAR) RECREATE THE SECOND HALF OF THE SAME SELECTION WITH FULL VOLUME AND UNIMPAIRED QUALITY.

## Introducing the "Berkshire"

*With Picturesque Tanglewood as the Setting, RCA Victor Displays and Demonstrates Its New Line of Custom-Built Combination Receivers.*

WITH the picturesque Music Shed of the Berkshire Music Festival at Tanglewood, near Lenox, Massachusetts, as the setting, and with the famed Boston Symphony Orchestra under the baton of Dr. Serge Koussevitsky supplying the musical background, a new combination radio-television-phonograph providing sound reproduction hitherto unachieved in a home instrument was demonstrated this summer to more than 6,000 music lovers, music critics and newswriters.

The combination instrument, called the "Berkshire," one of four custom-built models developed by RCA Victor and RCA Laboratories, revealed its capabilities when the full-sized symphony orchestra, after presenting the first part of Beethoven's "Egmont" Overture, ceased playing and let the new receiver take over for the balance of the selection. So perfect was the match in tonal range and quality that critics in the audience found it difficult to distinguish between the "live" and the electronically reproduced portions. This recording had been prepared especially for the occasion by the 103-piece Boston Sym-

phony Orchestra. By setting up a field recording unit in the Music Shed a few days before the demonstration, RCA Victor was able to duplicate on the record the exact acoustical conditions under which the comparative test was made on the day of the demonstration.

Unveiling of the "Berkshire" climaxed a dramatic stage presentation, "The March of Musical Fidelity" comprising a series of tableaux with orchestra, depicting significant milestones in recording and reproduction of music during the 37 years the Boston Symphony Orchestra has recorded for RCA Victor. Beginning with Edison's crude tin-foil covered cylinder and small horn, which was invented in 1877, the skits portrayed each outstanding development in sound reproduction, using actual working models of phonographs of the various periods to demonstrate the progress of the art.

### *Result of Long Development*

The "Berkshire", it was announced, is the result of more than a year of intensive development, employing for the first time post-

war applications of electronics in the engineering of sound.

The instruments incorporate a deluxe Victrola phonograph of unusual power, a radio which provides standard, frequency modulated broadcast and international short wave reception, including a motor-driven electric tuning mechanism, first perfected for use on military aircraft, and, in certain models, large screen projection television. The radio-phonograph chassis has 30 tubes, in addition to two rectifiers and two voltage regulators.

Among its unusual new and improved technical components, now making their initial appearance in this instrument, are a duo-cone loudspeaker and a new, extremely

CLOSE-UP VIEW OF THE "BERKSHIRE" MODEL USED IN THE TEST WITH THE BOSTON SYMPHONY ORCHESTRA.

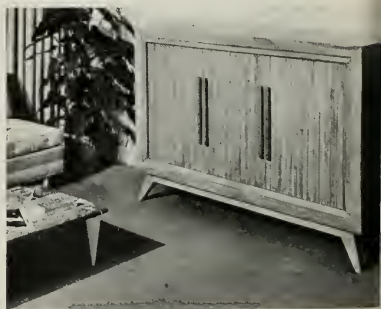

efficient noise suppressor, both perfected by RCA Laboratories at Princeton, N. J. Every component of the new instrument is capable of reproducing sound with a frequency range from 30 to 15,000 cycles, the full scale of human hearing.

To promote the manufacture and sale of these special instruments, a new Consumer Custom Products Department has been formed by RCA Victor under the management of Miss Harriett H. Higginson. As head of the new enterprise, Miss Higginson, a fashion and merchandising expert, and a former executive of Montgomery Ward & Co., and Marshall Field, will direct the activities of designers, technicians and specialists.

### *Contribute to Music Fund*

As part of the company's arrangement with the Boston Symphony Orchestra, a contribution will be made to the Berkshire Music Center Scholarship Fund on sales for which the Music Center is responsible. Every instrument sold under this subscription plan will bear a silver plaque, identifying it as one of a "special edition", and inscribing, over Dr. Koussevitsky's signature,

the purchaser as a benefactor of the scholarship fund.

Essentially a project for custom engineering of music into individual homes undergoing construction, the mechanical components of the Festival Series, of which "The Berkshire" is the first, will also be available in period designed cabinets ranging from a large traditional breakfront—a design by William Millington, associate of Baker Furniture, Inc.—to modern pieces designed by T. H. Robsjohn-Gibbings, New York. Lester Beall and John Vassos, well-known New York industrial designers, are associated in the project.

On the afternoon preceding the symphonic performance, scores of music critics and feature writers were given a preview of the Festival Series in the Chamber Music Hall on the Tanglewood grounds. Miss Higginson outlined the department which she heads; Marvin Hobbs, chief engineer of the Consumer Custom Products project explained the advanced technical features of the new line of instruments, and Dr. Harry F. Olson, of RCA Laboratories demonstrated the wide frequency range of the duo-cone loudspeakers used in the Festival series.

## Ingles Elected President of RCA Communications



MAJOR GENERAL H. C. INGLES.

Major General Harry C. Ingles (ret.) was elected President of RCA Communications, Inc., at the regular monthly meeting of the Board of Directors of Radio Corporation of America on September 5.

General Ingles is also a Director of Radio Corporation of America and of RCA Communications, Inc., having been elected on July 14, 1947.

DR. SERGE KOUSSEVITSKY LISTENS TO RECORDINGS OF HIS ORCHESTRA ON "BREAK-FRONT" MODEL OF THE "BERKSHIRE" LINE. MODEL HAS FM, AM AND TELEVISION.



## NBC Salutes UN Week

More than two hundred folk dancers performing their routine in the sunken plaza of Radio City, New York, on September 14, signaled the opening of United Nations Week, sponsored jointly by the National Broadcasting Company, the American Association for the United Nations and the National Education Association. In their colorful native costumes, groups from many nations presented their traditional dances and then combined in ensemble to portray the special symbolism of the Week. Speakers included Mayor William O'Dwyer of New York and Andrew W. Cordier, executive assistant to Secretary General Lie of UN.

After the opening day, UN programs were presented three times daily from the Plaza.

[RADIO AGE 23]



# ELECTRONIC TUBE-PAINTING

*Electrified Mist of Enamel Covers Metal Tubes More Evenly with  
Worthwhile Savings in Material and Labor.*

**B**Y the simple process of atomizing paint and then subjecting the minute droplets thus formed to an electrical charge of 80,000 volts, an electronic paint spraying machine at the RCA Tube plant in Harrison, N. J., applies the finishing coat of black enamel to 6,000 metal radio tubes every sixty minutes with a more uniform coating and a worthwhile saving in enamel. The only attendants required are two girls who load and unload the conveyors which carry the procession of tubes into the spraying chamber, through the later drying process and out onto the unloading platform. Formerly, the same tube output required the labor of six workers using wasteful hand-operated paint guns.

The machine operates on the well-known principle that an object carrying, for example, a charge of positive electricity, attracts another object or substance carrying a charge of negative electricity. In the electrostatic spraying method, the mist of paint particles is floated into the air between a grid of wires connected to a source of high voltage electricity. Each particle of paint thus becomes individually

charged. When a metal radio tube, connected to ground, is passed through this mist, the paint droplets are attracted to the metal surface and deposited there as a continuous coating.

The paint wasted in the electronic process is slight. Any paint particles that elude the tubes drop into a pool of water below the conveyor belt, or are caught by a water curtain and then carried to the water chamber. The paint floats on the surface of the water and is removed when enough has been accumulated to warrant the operation. As a matter of fact, so little paint is retrieved in this way that it is seldom worth salvaging.

## *Handspraying Wasted Paint*

In the earlier method of handspraying, a great amount of paint was sucked into the ventilating stack, but now the stack requires infrequent cleaning, thereby effecting another saving.

Immediately after being subjected to the paint-mist, the tubes on the conveyor belt pass around a sprocket wheel, and thence through an air-drying shield for 30 or 40 seconds before entering the baking oven. The purpose of the shield is to keep off lint and dust until the tubes enter the oven.

The oven is approximately 30 feet long and 6 feet wide, and contains sixty infra-red lamps. By using heat generated by these lamps, the paint reaches the curing temperature more rapidly than when the heat is produced by ordinary means such as open flames. The tubes are in the oven eight minutes, subjected to a temperature range between 275° F. on the skirt and 325° F. on the shell.

The conveyor belt and its load of tubes makes four complete turns within the oven before emerging for a two-minute cooling-off period, eventually ending up at the unloading platform.

The black paint used in the majority of cases is a melamine modified urea-formaldehyde-enamel, and is processed in a special mixing room to insure proper viscosity.

## RCA Income Increases In First Half of Year

The consolidated statement of income of the Radio Corporation of America and subsidiaries for the second quarter of 1947 and the first six months of the year, with comparative figures for the corresponding periods of 1946, issued by Brig. General David Sarnoff, President and Chairman of the Board of RCA, revealed that total gross income from all sources amounted to \$154,333,872 in the first half of 1947, compared with \$101,310,085 in the same period in 1946, an increase of \$53,023,787.

Net income, after all charges and taxes, according to the statement was \$8,825,912 for the first six months of 1947, compared with \$5,666,299 in 1946, an increase of \$3,159,613.

After payment of Preferred dividends, net earnings applicable to the Common stock for the first six months of 1947 were 52.2 cents per share, compared with 29.5 cents per share in the first half of 1946.

TWO WOMEN WORKERS EQUAL THE PRODUCTION OF SIX MEN WHEN ELECTRONICS ARE EMPLOYED TO APPLY PAINT TO METAL TUBES.

A PARADE OF METAL TUBES PASSES UNDER A SPRAY OF ENAMEL WHICH IS SUBJECTED TO AN ELECTRICAL CHARGE OF 80,000 VOLTS.

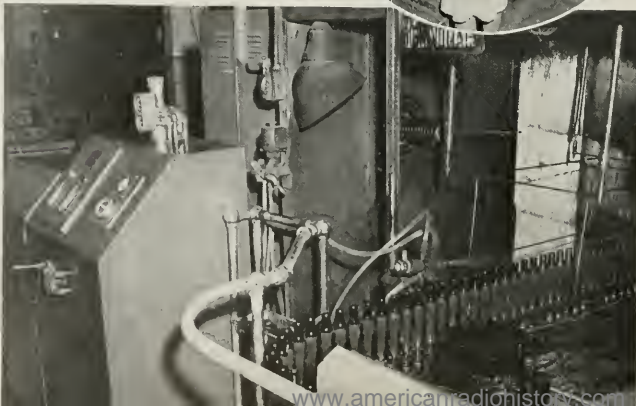





ABOVE: WITH AN ACCURACY OF ONE MILLIONTH SECOND, RCA ELECTRONIC INTERVAL COUNTERS ON TABLE MEASURE ELECTRON PULSES GENERATED BY THE FAINTEST STARLIGHT.

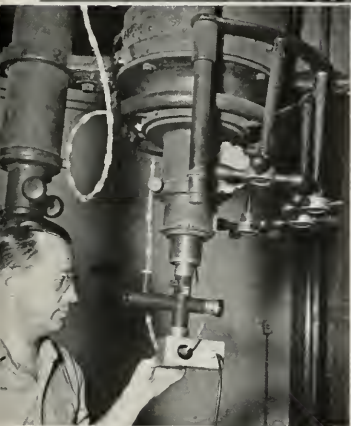

LEFT: A PHOTO-MULTIPLIER TUBE IS PLACED ON THE TELESCOPE WHERE IT RECEIVES THE FOCUSED IMAGE OF THE STAR BEING OBSERVED.

## MEASURES LIGHT OF FAINTEST STAR

*Method Uses Photo-Multiplier Tube and Electronic Counter*

THE amount of light reaching the earth from the faintest stars can now be accurately measured with a new form of photometer which incorporates two units developed by the Radio Corporation of America, the photo-multiplier tube and the Electronic Time Interval Counter.

Details of the photometer, which was designed and constructed by William Blitzstein and I. M. Levitt of the Flower Observatory and the Franklin Institute Laboratories, were revealed recently to the Astronomical Society in Evanston, Illinois.

In the Levitt-Blitzstein photometer, the image of the star is focused through a telescope onto a photosensitive element of the multiplier tube. The light striking this element gives off pulses of electrons which are then directed onto the first of a series of surfaces called dynodes which generate secondary electrons. For every electron striking the first surface, two to five additional electrons are released. By repeating these steps through the nine elements of the photomultiplier tube, the final product is a million or more electrons for each electron which left the first sensitive surface.

Previous methods used by astronomers for this purpose utilized a device called a galvanometer but the instrument is inherently unstable and reacts slowly to changes in the intensity of light pulses. Astronomers have long realized that if the bursts of electron pulses could be counted, the light from the faintest stars could be measured with great accuracy. In the RCA Electronic Counter, developed recently by the RCA Engineering Products Department, scientists found the solution to this problem.

The Counter makes the computa-

tion completely automatic. After setting a predetermined time interval on the device, the astronomer merely pushes a button, which exposes the counter to the output of the photomultiplier for the desired time, say 10 to 100 seconds, with an accuracy of 1 millionth of a second. The number indicated on the counter at the end of this period is proportional to the light intensity of the star under observation.

## Dr. Zworykin Addresses Foreign Science Groups

Carrying credentials naming him official representative of two of the outstanding science societies of the United States, Dr. V. K. Zworykin, Vice President and Technical Consultant of RCA Laboratories, Princeton, N.J., left New York on August 16 to attend important engineering conferences in Belgium, France and Italy, and to visit technical laboratories in England, Holland and Switzerland.

Recognized internationally as an authority on television and electron microscopy, Dr. Zworykin was invited to deliver three papers during his European trip. He represented the National Academy of Sciences at the Liege (Belgium) Congress, September 8, on the occasion of the centennial of the Association of Engineering Graduates of the University of Liege. He talked on "Applications of Electron Microscopy and Electron Diffraction to Metallurgy", a paper prepared in cooperation with Dr. E. G. Ramberg.

Later Dr. Zworykin addressed a conference of the French Society of Electrical Engineers at the Sorbonne, Paris, France, on the subject of "Progress in Television."

As representative of the National Academy of Sciences, the Institute of Physics, and Radio Corporation of America, Dr. Zworykin attended an international conference of radio engineers at Rome, Italy, organized by the Italian National Council of Research to commemorate the fiftieth anniversary of the invention of radio by Marconi. His address there also dealt with television, covering its latest advances.



PART OF RCA STAFF AT TELECOMMUNICATIONS CONFERENCE: STANDING—A. J. COSTIGAN, RADIOMARINE; MRS. JANE BROWN, SECRETARY; J. H. MULLER, COMMUNICATIONS; T. L. BARTLETT, FREQUENCY BUREAU. SEATED—ROGER NASH, COMMUNICATIONS; H. H. EDWARDS, COMMUNICATIONS; P. F. SILING AND J. P. VEATCH, FREQUENCY BUREAU.

## World Conference on Radio

*For Four Months, Delegations from 75 Governments and Representatives of Industry Have Been Revising the Basic Regulations of International Communications.*

THE first world conference on telecommunications since 1938 began at Atlantic City, N. J., May 12, 1947. The work of the three overlapping assemblies, viz., Radio, Plenipotentiary, and High Frequency Broadcasting, were concluded at the end of September. The progress of ten years in the communications art, including wartime developments, and the chaotic aftermath of the war in the regulation of radio, created the need for a complete overhaul of the basic international agreements, i.e., the International Telecommunication Convention of Madrid 1932, and the International Radio Regulations of Cairo 1938. The accumulated problems are capable of being resolved only with difficult and tedious work. Because of its interest in all phases of radio, including research, manufacturing and operations, RCA had a vital interest in substantially all phases of the conference proceedings.

The primary objective of the participation of RCA was to assist in securing for the United States maximum protection for its telecommunications services and in establishing the basis for cooperation among radio-operating agencies throughout the world. Our interests centered in the securing



By Philip F. Siling  
*Engineer-in-Charge  
RCA Frequency Bureau*

of world-wide agreement in the efficient use of the radio frequency spectrum so as to protect the frequencies used for world-wide communication by our operating subsidiaries and promote standardization of equipment in order to extend the market for RCA-manufactured equipment.

Further objectives included the effort to get agreement on our operating practices and methods, the protection of principles which bear on rates and the collection of charges, the establishment of suitable technical organizations, with provision for appropriate RCA representation, and the familiarization of our staff so that effective future work can be done in the

registration of frequencies, clearing of interference to operating circuits and prosecution of technical studies for preparation of future conferences.

Representation is required from a competitive standpoint and the scale of our effort was approximately the same as that of other radio-operating companies.

To a very considerable extent, the requirements of industry determined the position taken by the United States in the negotiations. Consequently, a great amount of work was required within the United States delegation in establishing the position of industry and reaching a final United States position. RCA representatives, who had the status of technical advisers, also frequently represented the United States as spokesmen in the formal meetings of the Conferences.

### *Seventy-five Nations Represented*

Some seventy-five governments had delegations attending these Conferences. The resolution of the problems presented could therefore be accomplished only through a series of compromises. Particularly in regard to frequency allocations, it was not sufficient to obtain favorable action by a majority, but in general it was necessary to obtain unanimous agreement in order to assure interference-free operation of the world's radio services. These factors suggest the very great effort that was required to get recognition of our policies in the final treaty documents.

It has been officially recognized by the representatives of our Government that RCA contributed substantially to the achievement of a favorable result, not only through direct participation in the preparatory work and in the Conference itself, but in furnishing a tremendous amount of information both from technical and practical operating standpoints, and in opening

its plants and facilities to organized tours and visits for the foreign delegations. RCA, as leader in the telecommunications field, fostered educational work among the foreign delegates in various radio technical matters. For example, RCA provided an illustrated lecture relative to radio propagation work and explained and demonstrated the present status of television and its possibilities for future expansion. As a result of these educational efforts, the foreign delegations will carry home with them a high opinion of the work and personnel of RCA.

#### *Assignments of Staff Members*

Concerning the work of RCA staff members, carried out under the direction of the author, Colonel T. L. Bartlett, Coordinator of Aviation Activities, RCA Frequency Bureau, participated actively in the organization committees of both Plenipotentiary and Radio Conferences. These committees completely revised the structure of the International Telecommunications Union and set up an International Frequency Registration Board which will review all future frequency notifications to the end that new assignments will not cause harmful interference. C. E. Pfautz, Assistant to the Engineer-in-Charge of the RCA Frequency

Bureau, and H. H. Edwards of RCA Communications, Inc., worked with the committee charged with the preparatory work of setting up a new International Frequency List based on sound engineering.

H. B. Martin, of Radiomarine Corporation of America; J. H. Muller, Assistant to the Chief Engineer, RCA Communications, Inc., and J. B. Coleman, Assistant Director of Engineering, RCA Victor Division, worked with the Technical Committee in setting up new technical standards to be followed by the radio industry in the future. Mr. Muller, together with Charles Sandbach of RCA Communications, Inc., followed the revision of the work of the Telecommunications Convention. A. J. Costigan, Vice President, Radiomarine Corporation, had a leading role in the important Operating Regulations Committee, which is revising the radio operating regulations for the world.

The writer devoted the major portion of his time to the important Allocations Committee, which determined the bands of frequencies available to the various services. He also helped on the Frequency List Committee. Frank M. Russell, Vice President, National Broadcasting Company, Inc., and W. S. Dutera, NBC Engineering Department, together with J. P. Veatch,

Manager of the Washington office of the RCA Frequency Bureau and the writer, were active on the High Frequency Broadcasting Conference, preparing for the task of frequency assignments in this service. Dr. C. B. Jolliffe, Executive Vice President in Charge of RCA Laboratories Division, gave overall guidance in our work.

#### *Frequencies Restricted*

At the outset, we were confronted with an inevitable restriction on the number of frequencies available for the point-to-point and marine services. However, as the decisions of the Radio Conference begin to take definite form, the prospects for favorable results are good from the point of view of reaching the goal of maintaining the complements of frequencies essential for our operating purposes.

In protecting the interests of the Company with regard to the manufacture and sale of equipment, and in the advancement of the American system with respect to rates, practices and methods of operation, the outlook is entirely favorable. At the conclusion of nearly four months' work at Atlantic City, it can be stated with confidence that the position of RCA as a leader in the world telecommunications field has been fully maintained.

## Television Makes Sports Fan of Toscanini



One of the new RCA table model television receivers installed in the home of Arturo Toscanini has made an enthusiastic sports follower of the noted NBC Symphony director. Prizefights, football and baseball, which were new to him, are now a regular part of the maestro's hours of relaxation. So avidly has he followed these televised events that in a space of a few months he has learned the fine points of the contests and the names of fighters and players. When he invites guests for dinner, he asks them to come early so that he will not miss the start of the telecasts.



# RADIO IN LATIN AMERICA

*Business and Government Leaders Below the Border Set Example in Modernizing Communications and Broadcast Services.*

PROGRESSIVE business and government leaders in a dozen Latin American countries are setting an example for the rest of the world in streamlining and modernizing vital communication and broadcasting services.

Plans which had been curtailed for several years because of war-inflicted shortages of equipment and materials began crystalizing soon after V-J Day. Since then there have been steadily increasing demands upon United States manufacturers to supply means and methods with which to effect desired improvements.

Orders being filled by the Radio Corporation of America through RCA International Division distributors reflect the high degree of vision and progressive thinking prevalent in the good neighbor republics.

New RCA installations planned or completed in Brazil, for example, include three powerful radio broadcasting transmitters and a radio system of communication for Volta Redonda, the Brazilian government's \$50,000,000 steel development enterprise. The radio transmitters met the recent Brazilian regulation requiring all clear-channel stations to operate on 50 kilowatts. The stations are: Radio Nacional, Radio Tupi and Radio Clube.



By Meade Brunet  
*Managing Director  
RCA International Division*

At Volta Redonda, destined to be the largest steel plant in Latin America, the management depends heavily upon radio communications to coordinate its production program. RCA radio transmitters and receivers have been installed at main points of the steel empire, not only linking each strategic unit with the operations center, but also connecting the center with the head offices in Rio de Janeiro.

The Volta Redonda and other Brazilian contracts were arranged by RCA Victor Radio, S. A., associate company of RCA in Rio Janeiro.

A \$2,000,000 radio development project is under way in Havana, Cuba, with plans calling for the erection of a "Radiocentro"—simi-

lar in many respects to New York's Radio City. The project includes a modern broadcasting station with eight studios, echo chambers, recording rooms and a master control room, completely equipped by RCA. The same group also is installing the first RCA FM broadcasting transmitter in Cuba.

Mexican government and business leaders are also active. Completed recently by RCA, was the powerful station XERF in the border town of Villa Acuna, State of Coahuila. This station, costing in the neighborhood of \$300,000 to build, is operating temporarily on 50,000 watts but its power may be increased to 150,000 watts. In addition to station XERF a number of other modern broadcasting stations have been installed in other parts of Mexico. They include stations XELG at Leon, XEAM in Matamoros, XEBT at Torreon and XEBS in Mexico City.

In Ciudad Trujillo, capital of the Dominican Republic, engineers have recently completed installation of an RCA 10-kilowatt station to be known as "La Voz del Yuna". It was purchased by Major J. Arismendi Trujillo, brother of the president of the Dominican Republic, who has also installed an RCA short wave station. A similar short wave transmitter has been erected by the Director General of Communications for the Republic.

President Raphael Trujillo has purchased Radiomarine radar and a complete shipboard installation of radiotelephone and radiotele-

*(Continued on page 31)*

BELOW: MODERN, AIR CONDITIONED HOME OF STATION WIAC IN SAN JUAN, PUERTO RICO.



ONE OF THE SEVERAL STUDIOS IN THE NEW BUILDING ERRECTED BY WIAC.

[28 RADIO AGE]

C. E. MOORE (CENTER) POINTS OUT FEATURES OF RADIOMARINE'S 3.2-CENTIMETER RADAR TO TWO TECHNICIANS ATTENDING THE TRAINING SCHOOL.

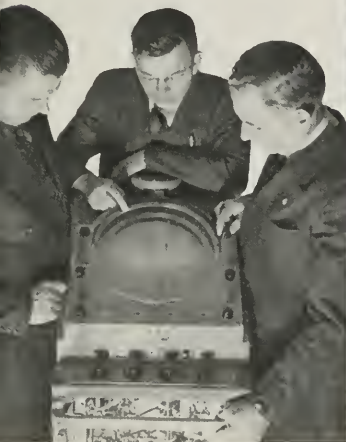

MEMBERS OF A CLASS AT RADIOMARINE STUDY METHODS OF SERVICING AND MAINTAINING MODERN RADAR UNITS FOR SHIPBOARD USE.

## SCHOOL FOR RADAR

*Radiomarine Trains Company Technicians and Merchant Marine Officers to Operate and Maintain Modern Aids to Navigation.*

WHEN it became evident early this year that the success of the first demonstration of Radiomarine's 3.2-centimeter radar on the Great Lakes would create a demand for many additional installations of these equipments, the company hastened to establish a school to train personnel in the installation, operation and servicing of the apparatus. Under the supervision of Charles E. Moore, Radiomarine engineer, a curriculum was arranged and a staff of specialized instructors assembled to teach the classes at company headquarters, 75 Varick Street, New York City.

The first classes were made up of experienced radio technicians and district managers selected from the company's 22 branch offices in this country and Canada, and from branch offices of the RCA International Division in Cuba, South America, Norway and Sweden.

The typical course, of two weeks duration, is divided into five main categories, each one taught by a

specialist in that subject. Lectures which explain each part of the radar circuit are supplemented by laboratory exercises in which the trainees are directed to locate faults in the apparatus and return it to a workable condition. The final two days of the course are devoted to a written test and a discussion of the test papers.

After attending the daily sessions, students are given required home-reading assignments to supplement the lectures and laboratory work.

Factory-trained personnel of this type have installed a large part of the 100 radars delivered and put into operation by Radiomarine since the first of the year.

These training facilities also are offered to Merchant Marine Officers, who learn about the service in one of two ways. When incoming ships are met by a messenger from the American Seaman's Friend Society, the captain is given a copy of Radiomarine's Radar

brochure. The messenger notes the Master's name and turns it in to Radiomarine. The latter then invites the captain to visit the Radar School for free instruction in the operation of the system and to view the radar in actual use.

This service to marine officers is further extended through an arrangement made with Commander Gilbert C. Fonda, Officer in Charge of the Radar-Loran School, of the U. S. Maritime Commission in New York. Before entering the Course at Varick Street, these Merchant Marine Officers are given lectures on the fundamentals of Radiomarine's Model CR-101 radar using an enlarged facsimile of the indicator unit and control panel installed in Commander Fonda's classrooms. This is followed by a one-day operational training course at the Radiomarine plant. Already many ship officers have completed the training.

Members of the school staff and the subjects they teach are: Melvin Meyer, Radar Receivers; William Turneau, Radar Antennas; Niles Barlow, Radar Transmitters; Richard Scanlon, Synchronizing Units and Edward Smith, Practical Aspects of Radar and Methods of Installation.

[RADIO AGE 29]

## NEW TUBE DETECTS LEAKS IN VACUUMS

**M**ICROSCOPIC leaks in the vacuum systems of cyclotrons, electron microscopes, refrigeration equipment, electron tubes, and vacuum stills can now be located quickly and simply by means of a new, portable leak locator developed by the Tube Department of the Radio Corporation of America. Operation of the unit depends on an ingenious tube of the ionization-gauge type which is sensitive only to hydrogen gas.

In operation, the gauge tube and the device under test are connected into a vacuum system and a fine jet of hydrogen played over the areas suspected of leakage. Any openings, no matter how small, will suck in hydrogen which quickly reaches the gauge tube. The latter features a small plate of palladium which when hot allows hydrogen but no other gases to pass through into the tube thereby creating a change in the

operating characteristics of the tube. This change is indicated on a sensitive meter.

In several years of factory tests, the indicator has been successful in locating tiny leaks in many types of vacuum tubes. When a small unexhausted electron tube is tested, its exhaust tube is plugged directly into the leak detector before the air has been exhausted from the tube. A rotary vacuum pump is then used to establish a vacuum throughout the system, including the tube under test. Next, a hood is lowered over the tube and filled with hydrogen gas. If a leak is present in the tube, even though so minute that molecules of air can barely pass through, seepage of the hydrogen will show on the meter. This procedure merely demonstrates the presence of a leak. To locate the faulty spot exactly, the hood is removed and a fine jet of hydrogen played slowly over suspected areas until a movement of the meter marks the leak.

The leak detector weighs only 25 pounds complete and can be handled



THIS DETECTOR USING NEW VACUUM GAUGE TUBE LOCATES LEAKS SO SMALL THAT MOLECULES OF AIR CAN SCARCELY PENETRATE THROUGH OPENINGS.

by non-technical personnel.

RCA has developed several other types of vacuum-gauge tubes of extreme sensitivity. They are used for measuring gas pressures and as protective devices in vacuum systems.



KEN R. DYKE



HARRY C. KOPF



JOHN H. MACDONALD

## NBC MAKES CHANGES IN EXECUTIVE STAFF

**R**EALIGNMENT of the executive organization of National Broadcasting Company, resulting in the naming of three administrative vice presidents and the promotion of other personnel, was announced August 1, by Niles Trammell, NBC president, following a meeting of the network's Board of Directors.

Harry C. Kopf, formerly vice president in charge of Sales, was appointed administrative vice president in charge of Network Sales, National Spot Sales, Owned and Operated Stations and Station Relations. George H. Frey was named director of Network Sales. James M. Gaines was named director of Owned and Operated Stations and will continue as manager of station WNBC.

Ken R. Dyke was appointed ad-

ministrative vice president in charge of Program, Continuity Acceptance and Public Service Departments of the company. Mr. Dyke will continue in charge of Broadcast Standards and Practices.

John H. MacDonald, formerly vice president in charge of Finance, was appointed administrative vice president. Mr. MacDonald will have charge of finance and budget matters and in addition, will supervise the following departments: Treasurer's, Controller's, Personnel, General Service and Guest Relations.

I. E. Showerman, former manager of the Central Division, was elected vice president in charge of that Division.

Mr. Trammell also announced the retirement of two executives of the company—A. L. Ashby, vice president and general counsel, who will continue to act as an advisor to the company on legal matters, and Clarence L. Menser, vice president of Production and Program Departments. Henry Ladner was designated acting general counsel of NBC.



# Radio in Latin America

(Continued from page 28)

graph equipment for his yacht.

In Peru the *Compania Nacional de Telefonos* (National Telephone Company) has embarked on a program of modernization which includes provision for radiotelephone service connecting five of the country's principal cities—Lima, Arequipa, Iquitos, Cuzco, and Piura. Used in this project will be the latest design RCA equipment including: six transmitters, twelve receivers, two control racks at each station, emergency power generating equipment, cage-type antennas and transmitting towers. Installation of three short-wave radio transmitters have been made recently aboard ships of the Peruvian Merchant Marine.

"Radio America", in Lima, is increasing its power to 10 k.w., another RCA installation.

The Ministry of National De-

fense of Venezuela has purchased Radiomarine equipment for 14 ships. Three of the ships are being equipped with transmitters and all are to be equipped with the latest radiotelephone apparatus.

Arrangements have been completed for installation of a new 5 k.w. broadcasting station and associated RCA FM broadcast transmitter in Barranquilla, Colombia, for the network "Emisores Unidas", managed by Raphael Roncallo. A 10-kilowatt RCA radio broadcasting transmitter was recently installed in the city of Medellin for station "Siglo Viente" and its companion station "La Voz de Antioquia."

In Puerto Rico, center of intense radio activity, engineers have completed installation of an RCA 10 k.w. medium frequency broadcast transmitter in San Juan for station

WAPA, owned by Jose Ramon Quiñones.

In San Juan, WIAC has inaugurated an attractive new air-conditioned building, especially designed for modern broadcasting, and RCA equipped. The newspaper "El Mundo" of San Juan, is going on the air with an RCA 5 k.w. transmitter. From Ponce, the Puerto Rican American Broadcasting Corporation station WPAB will cover its market with new RCA 5 k.w. equipment.

One of the first stations in Latin America to streamline its facilities and step up its power was station CB 114 in Santiago de Chile.

The Argentine government-owned petroleum company, Yacimientos Petroliferos Fiscales, is installing complete RCA radio-telegraph units aboard seven of its oil tankers.

## Pasteurizing Milk by Radio

(Continued from page 16)

pure tin which, in turn was submerged in a tank of warm water. The milk then flowed through the electrodes and was cooled by passing over a set of fins through which ice water was pumped.

When samples of the milk pasteurized by this method were tasted, however, it was discovered that there was a definite cooked flavor whenever the milk had been heated to 190°F or higher.

The importance of maintaining the flavor of milk in any pasteurizing process is well-known to dairy plant operators, and this defect of the process was recognized immediately by the scientists.

It was decided that the cooling time of approximately 5 seconds apparently was too long. More rapid cooling was, however, achieved by injecting the milk stream into a vacuum chamber. The heating time was maintained at 67/1000 of a second but the cooling time by this method was reduced to 2/10 of a second. The milk was cooled to 135°F by means of the vacuum ex-

pansion then the milk was poured over cooling fins and reduced to 40°F.

Samples for bacteriological tests were taken at the conclusion of the vacuum expansion, and cream volume samples were taken at the lower temperatures. Samples of milk which were tested showed no traces of cooked flavor at any temperature used. Even a sample taken at 205°F could not be differentiated from the raw milk.

Bacteria count was reduced to 100 as compared to 48,300 normally found in milk pasteurized by the conventional method at 143°F for 30 minutes. *Bacillus coli* was zero as compared to plus two in the conventional method.

Pasteurization by radio heat is so new that many questions remain as to the exact effect of the method, but perhaps the most striking and promising fact of all is that milk so treated keeps longer than pasteurized milk which we drink today.

While ordinary pasteurization kills most of the biological harmful

bacteria found in milk, other non-harmful bacteria stay in the milk and cause it to sour. By eliminating these heat-resistant bacteria, progress has been made toward the development of a longer-keeping milk.

One of the chief limitations of the new process is that it can only be used to produce homogenized milk. However, with greater quantities of homogenized milk being sold today than ever before it is conceivable that its acceptance will be widespread in a few years.

Experiments worked out by RCA in cooperation with the Walker-Gordon Company and the Borden Company, large Eastern dairy products producers, provide for a continuous radiation treatment which promises a possible foreshortening of milk-processing operations. The experiments, however, have been limited to the laboratory and at the present time interest of milk producers is not deemed sufficient to warrant commercialization of the system.

[RADIO AGE 31]

*Aboard*

## MISSISSIPPI VALLEY BARGE LINE TOWBOATS



Capt. Eugene Roberts does some close-range steering with the aid of Radiomarine Radar.

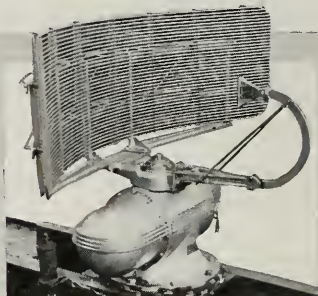

Radar antenna atop the ERNEST T. WEIR provides ample clearance for bridge structures.



*You'll see*

# RADIOMARINE 3.2 cm RADAR

After months of successful operation aboard the ERNEST T. WEIR, the Mississippi Valley Barge Line Co. is now equipping six other towboats in their fleet with Radiomarine 3.2 cm Radar.

Aboard radar-equipped towboats, the pilot watching the radar screen sees a large, sharp, maplike picture of the river area. Regardless of weather or poor visibility, he clearly sees buoys, locks, bridges, chutes, sandbars, islands, river banks and river traffic. With the aid of radar the pilot steers a safe course around sharp bends in the river . . . in darkness, fog or storms.

Naturally Radiomarine Radar quickly pays for itself by freeing towboats and their pay loads from delays caused by bad weather.

Factory-trained technicians in 22 wholly owned service stations stand ready to install, service and maintain Radiomarine equipment at principal ports nation-wide.

That's why so many American and foreign ships are now equipped with Radiomarine Radar.

We're in full production and making installations daily! For further details on Radiomarine Radar for sea and inland

navigation write: Radiomarine Corporation of America, Dept. 00-0, 512 Auditorium Bldg., East 6th Street and St. Clair Avenue, Cleveland 14, Ohio. Tel.: Prospect 4441, or: offices below.

### YOU GET THESE ADVANTAGES with Radiomarine Radar

- 12-inch viewing scope
- 86 square inches of picture area
- clearer, larger, steadier pictures
- sharp definition between closely spaced and low-lying objects
- true or relative bearings
- range 80 yards to 50 miles

Chicago, Ill.  
228 North La Salle St.  
Tel.: Central 9387

St. Louis, Mo.  
Foot, Rutger St.  
Tel.: Chestnut 4574

New Orleans, La.  
500 St. Peter St.  
Tel.: Raymond 8124



**RADIOMARINE CORPORATION of AMERICA**

A SERVICE OF RADIO CORPORATION OF AMERICA

# Radiophoto Service



ARGENTINA  
 AUSTRALIA  
 EGYPT  
 FRANCE  
 GREAT BRITAIN  
 HAWAII  
 INDIA  
 ITALY  
 SWEDEN  
 SWITZERLAND  
 U.S.S.R.

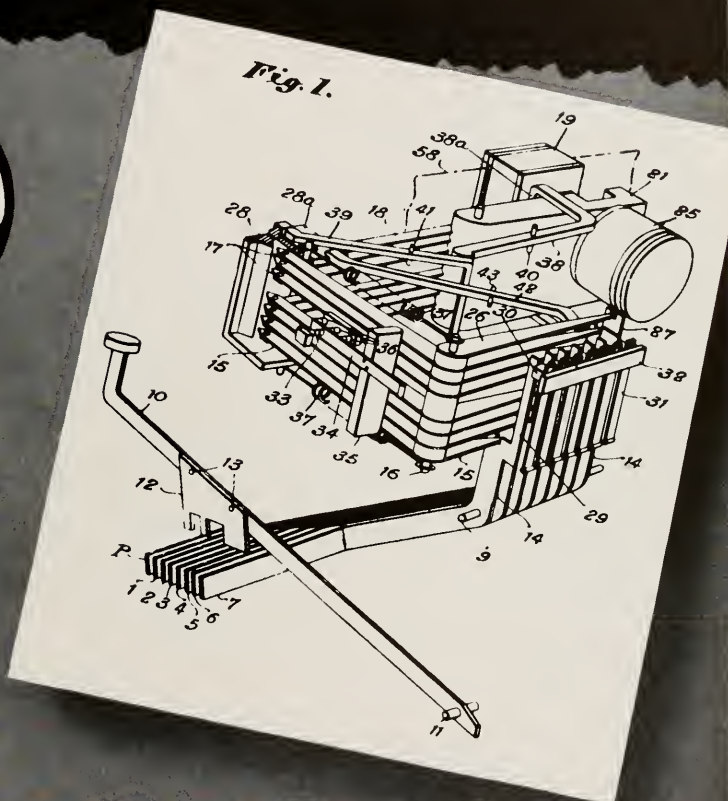

*Error-Proof Copies of*

INDUSTRIAL DRAWINGS • LEGAL DOCUMENTS  
 FINANCIAL STATEMENTS • PHOTOGRAPHS

Address inquiries to  
 RADIOPHOTO DEPARTMENT

**RCA COMMUNICATIONS, INC.**

A Service of Radio Corporation of America

64 Broad Street

New York 4, N. Y.

Telephone HANover 2-1811

**\$20.00**

for a minimum of 150  
 square centimeters

**\$10.00**

for each additional block  
 of 100 square  
 centimeters





*Your enjoyment climbs to new altitudes through radio and television achievements of RCA Laboratories.*

***RCA LABORATORIES—your "magic carpet"***

***to new wonders of radio and television***

More and more people will go sight-seeing by television as the number of stations and home receivers increases. Eventually, television networks will serve homes from coast to coast . . . bringing you the news as it happens . . . sports events . . . drama . . . vaudeville.

Many of the advances which have made possible these extended services of radio-electronics, in sound and sight, originated in research conducted by RCA Laboratories.

Recent RCA "firsts" include: ultra-sensitive television cameras that give startling clarity to all-electronic television . . . tiny tubes for compact, lightweight portable radios . . . "picture tube" screens for brilliant television reception.

In other fields of radio-electronics, RCA has pioneered major achievements—including the electron microscope. Research by RCA Laboratories goes into every product bearing the name RCA or RCA Victor.

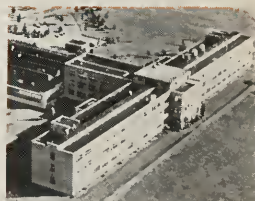

RCA Laboratories at Princeton, N. J., one of the world's centers of radio and electronic research. • When in New York City, see the radio-electronic wonders on display at RCA EXHIBITION HALL, 36 West 49th Street. Free admission. Radio Corporation of America, Radio City, New York 20.



**RADIO CORPORATION of AMERICA**

[www.americanradiohistory.com](http://www.americanradiohistory.com)

# Science in Democracy

BRIGADIER GENERAL DAVID SARNOFF URGES SCIENTIFIC PREPAREDNESS FOR NATIONAL SECURITY—REVOLUTIONARY CHANGES IN WARFARE AND COMMUNICATIONS FORESEEN.



By Brig. General David Sarnoff  
*President,*  
*Radio Corporation of America*

*An address before the American Academy of Political and Social Science in Philadelphia on October 5, 1945.*

**A**MERICA, to be first in Peace and first in War, must be first in Science.

To achieve this, we must have democracy in science as well as science in democracy.

The essence of science is freedom to question and to experiment, with an opportunity to draw conclusions, unrestricted by any forces that would hamper liberty in thinking. The realm of study, investigation and development, must be free. Whether in politics or in science, it is the keynote of democracy that people must be free to think, free to discuss, and free to try their ideas in practice. To impose the opposite is tyranny.

That is one of the great lessons of World War II. We should not embrace victory merely as a tri-

umph and let it rest as such in history books. We should study its lessons to cultivate progress and to safeguard the future. With peace comes the vivid truth that to be strong in this modern world a nation must have science ever ready to march with its Army, to sail with its Navy, and to fly with its Air Force. Indeed, some products of science, such as an atomically-powered missile, must be ready to fly through the air instantly, unattended by sailor, soldier, or pilot; guided to its target by push-buttons in a control room far away.

Such an alliance of science and military power can be achieved most effectively under the democratic form of government. The fate of Germany and Japan is evidence enough. Despite an earlier start by Germany in the creation and development of scientific weapons of war, the democracies were able to outdistance the enemy in this domain. If there be any doubt, let the doubter look to radar and atomic power. Developed and harnessed by democracy, they searched out the enemy and wiped out despotism. Our scientists gave their best voluntarily, while those of the Axis powers worked under duress. Democracy, unhampered by prejudices and obsessions about race and creed, was able to utilize the knowledge and brain power not only of its own scientists but of many who had been ruthlessly banished from their homelands by the dictators.

## *Freedom to Pioneer*

For many years past, scientists from foreign lands have come to our shores and settled here so that they could study and experiment free from oppression, free from commands, and free from regimen-

tation. Prominent among them we find Tesla, Steinmetz, Pupin, Einstein, Michelson, Zworykin, Fermi, and many others. Here they found the environment conducive to study and research, to free exchange of ideas, to experiment and discovery. Our nation has profited by their endeavors, and science has advanced.

America, the cradle of liberty, is also the cradle of invention. The list of our native scientists and inventors is a shining roll of honor. As a result, thousands of wartime scientific accomplishments helped to turn the tide of victory for the United Nations and thus rescue democracy from those who would destroy it. Scientists in democracy must continue to pioneer on an ever-expanding scale. We must be as daring in peace as in war. We must follow our vision with the same confidence if we are to cross new frontiers of progress. Through new products, processes and services that science can create, we should gain a fuller life, increased employment, improved health and national security. We must cultivate our natural talents and resources to meet the promise of science if we are to develop its endless opportunities for securing a higher standard of living for the masses of people everywhere.

## *Vigorous Policy Needed*

It is imperative, therefore, that the United States maintain a vigorous national policy for the promotion of science. Statesmen, philosophers and religious leaders have led in the past—now scientists must join them in the vanguard of civilization. In the future, freedom and science must walk together, hand-in-hand as the spearheads of peace.

For this purpose, every phase of

[RADIO AGE 3]